

THE KIA EV9 FACTS & FIGURES GUIDE



Movement that inspires

THE KIA EV9 INDEX

1 Overview

- 6 Exterior Design
- 8 Charging the Kia EV9
- 10 Cockpit & Controls
- 14 Frunk & Trunk
- 16 Test Drive Fleet

2 The Kia EV9

- 20 Electromobility
- 21 Exterior Dimensions
- 21 Interior Dimensions
- 22 Exterior Color Concepts
- 23 Interior Color Concepts
- 24 Electric Global Modular Platform (E-GMP)
- 26 Powertrain System
- 28 Battery Technology
- 30 Multi-Fast Charging System
- 31 Bi-Directional Charging

3 Driving

- 36 Powertrains
- 38 Aerodynamics
- 40 All-Electric Range
- 42 Drive Mode Select
- 43 Terrain Mode Select
- 44 Steering System
- 46 Regenerative Braking System
- 48 Structure & Stiffness
- 49 Acoustics & NVH
- 50 Towing
- 51 Safety

4 Advanced Driver Assistance

- 54 Parking Distance Warning
- 54 Parking Collision-Avoidance Assist
- 55 Rear Cross-Traffic Collision-Avoidance Assist (RCCA)
- 56 Safe Exit Warning & Assist
- 57 Remote Smart Parking Assist 2
- 58 Blind-Spot Collision-Avoidance Assist
- 59 Blind-Spot View Monitor
- 59 Surround View Monitor
- 60 High Beam Assist & Intelligent Front Lighting System
- 61 In-Cabin Camera
- 62 Forward Collision-Avoidance 2
- 63 Intelligent Speed Limit Assist
- 64 Lane Following Assist 2 & Lane Keeping Assist
- 65 Highway Driving Assist 2
- 66 Smart Cruise Control

5 Comfort & Convenience

- 70 Sustainable Interior
- 71 Seat Configurations
- 72 Seat Functionalities
- 73 Ergo Motion Seat
- 74 Relaxation Seats
- 74 Ventilated & Heated Seats - 2 Rows
- 76 HVAC System
- 77 Dual-Color Ambient Lighting
- 78 Head-Up Display
- 79 Intuitive Usage
- 80 Digital Center Mirror
- 81 Digital Exterior Mirrors

6 Infotainment & Connectivity

- 84 Connected Car Navigation Cockpit
- 86 Triple Panorama Display
- 88 Kia Connect
- 90 Kia Upgrades
- 92 Digital Key
- 93 Premium Sound System



THE KIA EV9 Overview



Exterior Design

The Kia EV9 displays a unique blend of EV sleekness and SUV toughness. The available trims, GT-line and Baseline, are distinguished through a multitude of details like dedicated front and rear bumpers, different head lamps, wheels and much more.



Exterior Design

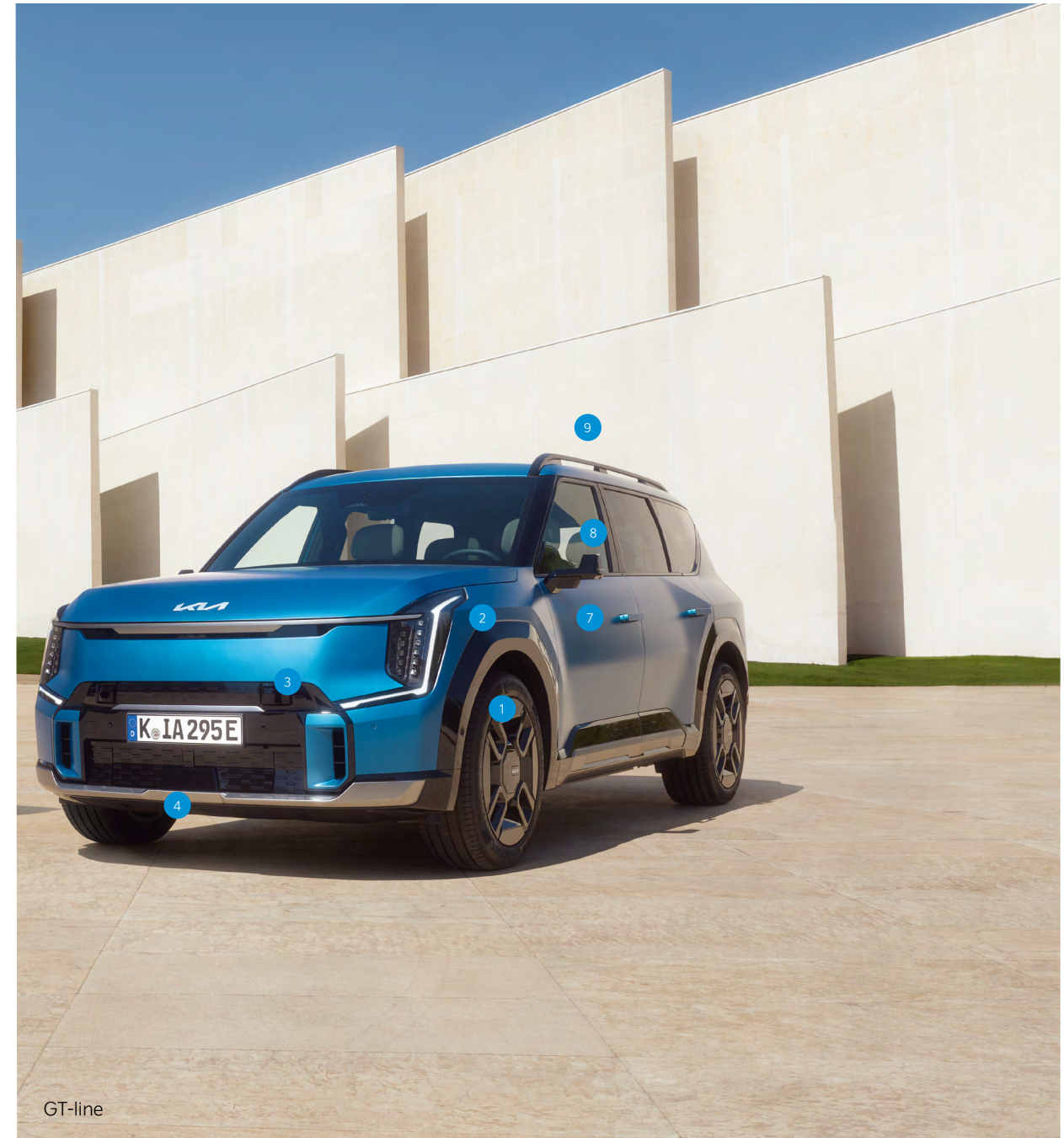

- (1) Dedicated wheels: 21" GT-line and 19" Baseline
- (2) GT-line small cube LED-headlamps and day time running
- (3) Digital Tiger Face
- (4) Dedicated front bumper & active air flaps
- (5) Starmap rear LED taillights
- (6) Dedicated rear bumper
- (7) Automatic flush handles
- (8) Digital exterior mirror
- (9) Dedicated roof rails

Charging the Kia EV9

The Kia EV9 is equipped with a Combined Charging System (CCS) socket on the vehicle's right-hand side. This allows for ultra-fast charging - up to 210 kW - thanks to the multi-input charging system that is compatible with both 400V and 800V infrastructure.



Charging the Kia EV9

How does it work?

The charging doors can be opened by using the electronic push-to-open functionality directly at the charging door when the car is unlocked.

It can also be remotely opened and closed via the button inside the car or via the Kia Connect App. After charging, simply close it again by pushing the button next to the charging port.



Charging indicator lamps

The lights indicate how high the State of Charge (SoC) is.

- A permanently lit charging bar indicates that the SoC range representative for the respective luminaire has already been reached
- A flashing charging bar indicates that the SoC area representative of the respective luminaire is being completed

State of Charge Level (%)

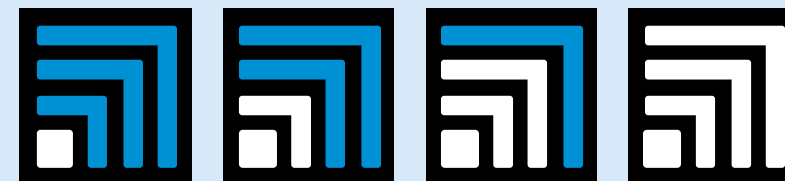

0-24

25-49

50-74

75-100

Cockpit & Controls

The interior of the EV9 integrates Kia's "Opposites United" design philosophy in every part. The O-shaped design of the crashpad expresses SUV solidness, while the straight lines of the air vents, displays, and ambient lighting are integrated perfectly.



Cockpit & Controls



- (1) 12.3" Cluster
- (2) 5.3" Climate control segment display
- (3) 12.3" Infotainment touchscreen
- (4) Illuminated Kia logo (in READY mode)
- (5) Driving assist buttons
- (6) Audio remote control buttons
- (7) Gear select lever
- (8) Motor start-stop button
- (9) Drive Mode Select / Terrain Mode Select
- (10) Hidden multimedia buttons
- (11) Quick select buttons for temperature, volume etc.
- (12) USB-C ports for multimedia & charging + 12V port
- (13) Driver support buttons
- (14) Fingerprint authentication
- (15) Window and mirror controls
- (16) Seat heating, seat ventilation, ergo motion seat and heated steering wheel
- (17) Digital mirrors - displays and cameras

Cockpit & Controls

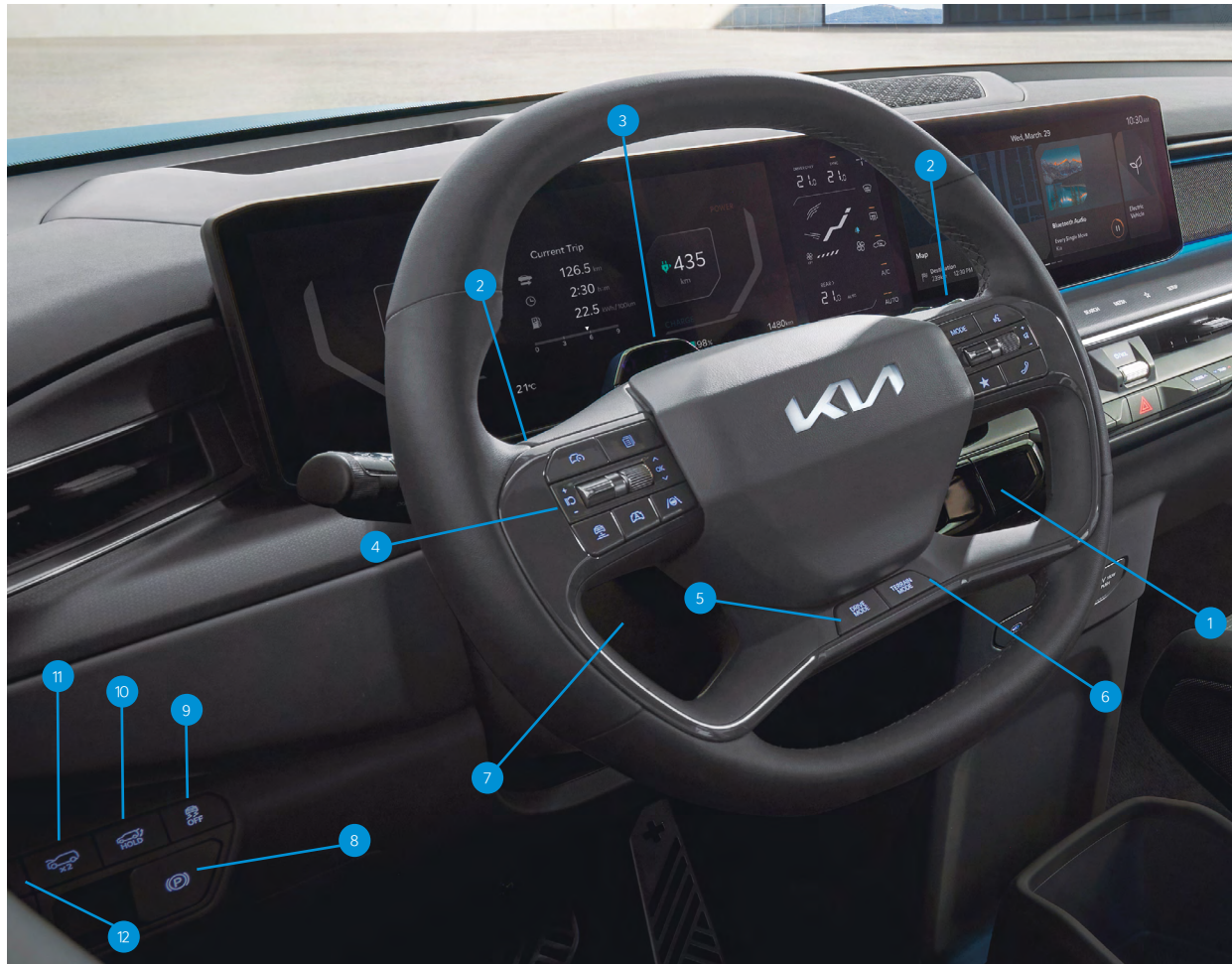

- (1) Gear selector / start-stop button
- (2) Paddle shifter for regenerative braking
- (3) In-Cabin Camera - driver
- (4) Driving assist buttons
- (5) Drive Mode Select
- (6) Terrain Mode Select
- (7) Steering wheel adjustment (electronic / memory)
- (8) Electric parking brake
- (9) ESC OFF
- (10) Open / close smart power tailgate
- (11) Unlock hood for frunk access (press twice)
- (12) Open / close charging door

Cockpit & Controls

- (1) USB-C ports for multimedia & charging + 12V port
- (2) Hazard light button
- (3) Wireless smart phone charging station
- (4) Fingerprint authentication (user profiles and motor start)
- (5) Auto hold
- (6) Downhill brake control
- (7) Surround view camera and Remote Smart Parking Assist 2
- (8) Parking Distance Warning
- (9) Bi-color ambient lighting
- (10) Passenger seat control buttons

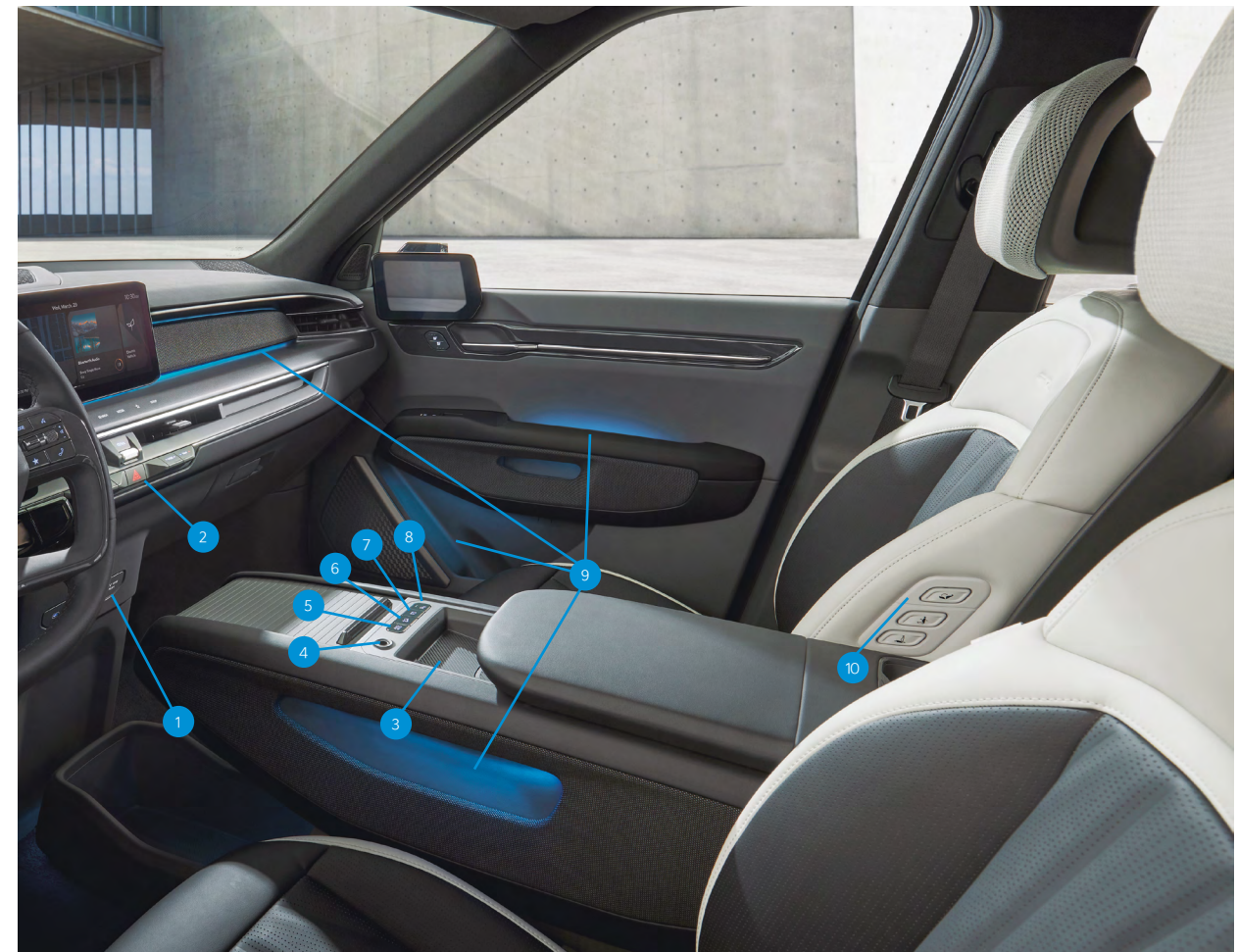

Frunk & Trunk

The Kia EV9 offers a convenient Frunk (Front Trunk) with 52 liters (AWD) or 90 liters (RWD) of additional storage space.



Accessing the Frunk

Unlock the hood via your Smart Key, Digital Key, the Kia Connect App or the interior button and conveniently access the Frunk.

For emergency cases, there is also a mechanical lever hidden in the driver's leg area, and even an opening button inside the frunk.

Frunk & Trunk

In the Kia EV9 up to seven passengers can travel comfortable with their luggage. Depending on the seating layout, the trunk volume ranges from 312 liters to 2,993 liters with the second- and third-row seats folded.

Accessing the Trunk

Conveniently unlock the trunk via your Smart Key, Digital Key, the Kia Connect App or the interior button.

It will also open automatically if you approach it with your Smart Key or Digital Key in your pocket.



Test Drive Fleet

Technical Specification

Type	Battery Electric Vehicle (BEV)
Engine	Permanent Magnet Synchronous Motor
Gearbox	Single Speed Reduction Transmission
Drivetrain	All-Wheel Drive
Power Output - Combined	282.6 kW (384 HP @ 4000~7800 rpm)
Power Output - Front	141.3 kW (192 HP @ 4000~7800 rpm)
Power Output - Rear	141.3 kW (192 HP @ 4000~7800 rpm)
Torque - Combined	700 Nm @ 0~3800 rpm
Torque - Front	350 Nm @ 0~3800 rpm
Torque - Rear	350 Nm @ 0~3800 rpm
Top Speed	200 km/h
Acceleration 0-100 km/h	5.3 sec
Battery Capacity	99.8 kWh
AER - combined	505 km (WLTP, combined)
AER - city	668 km (WLTP, city)
CO2 Emissions*	0 g/km
Energy Consumption*	22.8 kWh/100 km
On-Board Charger (AC)	11 kW
Max. Charging Power (DC)	210 kW
Min. Charging time 10-80%	24 min.
Max. Kilometer charged in 15 min.	223 km (21" wheels AWD)
Dimension - Exterior (LxHxW)	5,015 x1,980 x1,780 mm
Wheelbase	3,100 mm
Max. Curb Weight	2,648 - 2,674 kg
Max. Gross Weight	3,240 kg
Max. Towing capacity - Braked	2,500 kg
Max. vertical Load	125 kg

*Consumptions and emissions were determined according to the standardized EU measurement procedure (WLTP). The individual driving style and other external factors have an influence on the actual efficiency. (October 2023)



Test Drive Fleet

Test cars are equipped with following items as standard

Advanced Driver Assistance Systems

- ✓ Airbags in all 3 rows
- ✓ BCA - Blind Spot Collision-Avoidance
- ✓ BVM - Blind Spot View Monitor
- ✓ DBC - Downhill Brake Control
- ✓ FCA 2 - Forward Collision-Avoidance
- ✓ HDA 2 - Highway Driving Assist - with Hands-on Detection
- ✓ In-Cabin Camera - Driver Safety
- ✓ LFA 2 - Lane Following Assist & LKA - Lane Keep Assist
- ✓ Multi Collision Brake
- ✓ N-SCC - Navigation-based Smart Cruise Control
- ✓ PCA - Parking Collision-Avoidance - front/side/rear
- ✓ SEA - Safe Exist Assist
- ✓ SVM - 360° Surround View Monitor
- ✓ TSA - Trailer Stability Assist

Interior, Comfort & Convenience

- ✓ Bio-based artificial leather seats
- ✓ Digital Key 2.0
- ✓ Driver Ergo Motion Seat
- ✓ Driver Seat automatic bolster adjustment
- ✓ Heated and ventilated seats - Driver & Passenger
- ✓ Heated and ventilated seats - 2nd row outer seats
- ✓ Illuminated KIA Emblem - steering wheel while driving
- ✓ ISOFIX - 2nd & 3rd row - 4 seats
- ✓ Memory Driver seat with aircell lumbar support
- ✓ Memory Function - steering wheel
- ✓ Power Seat Passenger with Aircell Lumbar support
- ✓ Premium Relaxation Seats - driver & passenger
- ✓ Self-Levelizing - rear suspension

- ✓ Smart Key
- ✓ Smart Power Tailgate
- ✓ Artificial suede roof trim
- ✓ Vehicle-to-Load (V2L) - Interior Socket
- ✓ 3-Zone A/C

Multimedia

- ✓ Fingerprint authentication with engine start
- ✓ USB-C Chargers - in all 3 rows
- ✓ USB-C multimedia input
- ✓ Wireless smartphone charger
- ✓ 5.3" Segment Display for Climate Control
- ✓ 12.3" Infotainment Display
- ✓ 12.3" Cluster

Exterior

- ✓ Automatic Flush Handles
- ✓ Bridge Type Roof Rack
- ✓ Dynamic Welcome Light - front and rear lights
- ✓ Heated, electrochromic exterior mirrors
- ✓ Laminated glass - windshield, 1st & 2nd row
- ✓ LED Headlamps with Intelligent Front Lighting System
- ✓ Memory Function - exterior mirrors
- ✓ Privacy glass - rear windows
- ✓ RSPA 2 - Remote Smart Parking Assist
- ✓ 21" Alloy wheels with Continental tires

EV Specific

- ✓ Battery Heating System - battery conditioning function
- ✓ Heat Pump
- ✓ Regenerative Braking System with paddle adjustment

All test cars are equipped with this optional equipment

- ✓ Electrochromic interior mirror with Full-Display
- ✓ HUD - Head-Up Display
- ✓ Vehicle-to-Load (V2L) - exterior connector
- ✓ 14-speaker Meridian Premium Soundsystem w/ext. amplifier

Some test cars are equipped with this optional equipment

Dual Sunroof

6-Seat Relaxation Seating Layout

- 2nd row seats with Relaxation function
- Extending drawer center console
- Wing-out headrests

6-Seat Swivelling Seating Layout

- 2nd row seats can swivel by 90° or 180°
- Extending drawer center console

7-Seat Seating Layout

THE KIA EV9



Electromobility

The Kia EV9 brings the electric SUV of tomorrow to the world of today. With the EV9, Kia makes its debut in the five-meter SUV class in Europe, tapping into a premium niche of the automotive market.



The adventurous 6- or 7-seater SUV is rugged yet sophisticated, paving the way to emission-free, connected, and autonomous mobility.

The Kia EV9 is an all-electric SUV designed and built for modern lifestyles in the electrified era.

Exterior Dimensions

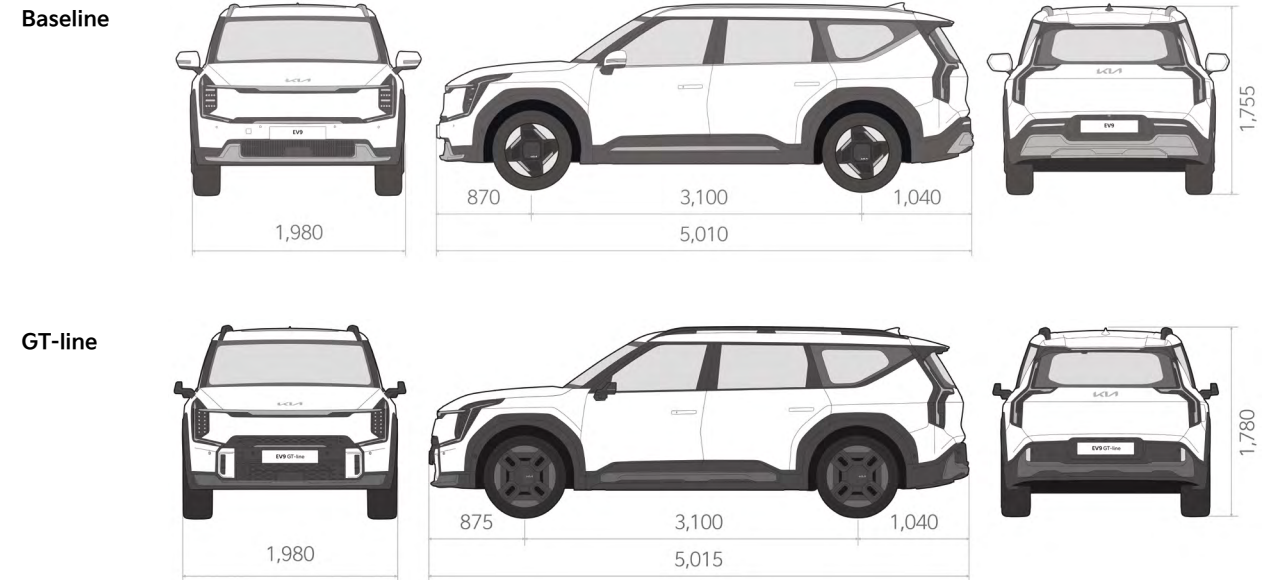

Interior Dimensions

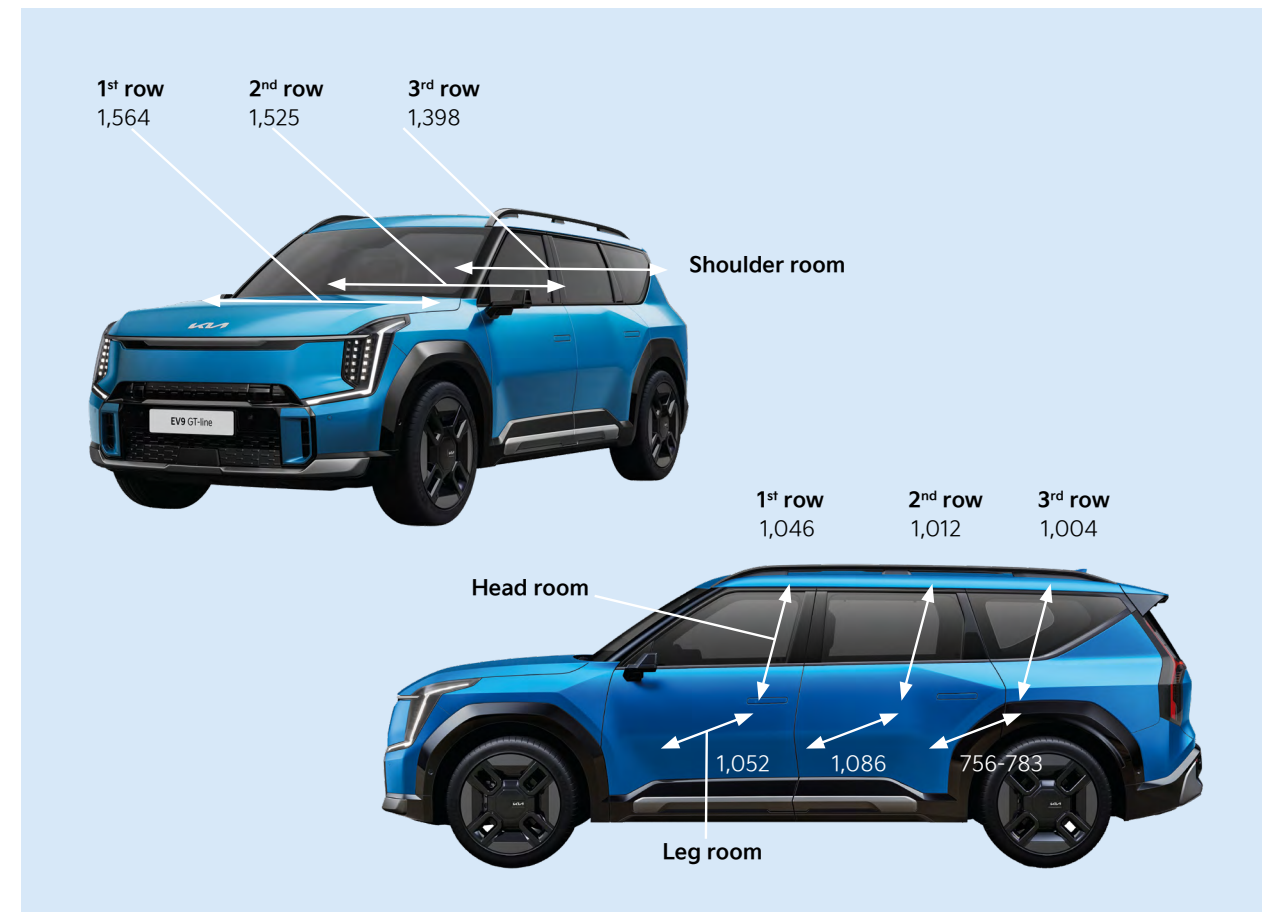

Exterior Color Concepts

For the individualization of one's EV9, a total of nine different colors are available: five shared among both trims and two exclusive colors for each trim.

GT-line & Baseline



Aurora Black Pearl



Flare Red



Iceberg Green



Pebble Gray



Snow White Pearl

GT-line Exclusive



Ocean Blue Glossy



Ocean Blue Matt

Baseline Exclusive



Ivory Silver Glossy



Ivory Silver Matt

Interior Color Concepts

In the cabin, there is also a wide choice of bi-color interior concepts available per trim.

GT-line



Light Gray & Black



Dark Gray & Navy

Baseline Premium



Dark Gray & Black



Dark Gray & Light Gray



Black & Brown (to be introduced)

Baseline



Dark Gray & Black

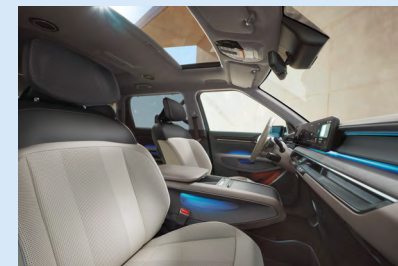

Dark Gray & Light Gray

Electric Global Modular Platform (E-GMP)

The EV9 is the second Kia model utilising the full potential of the Electric Global Modular Platform (E-GMP). This scalable platform can be extended in order to fit a vehicle with a longer wheelbase and a larger battery pack, while still keeping the existing advantages - namely, ultra-fast charging, long driving ranges, and a spacious interior.



Electric Global Modular Platform (E-GMP)

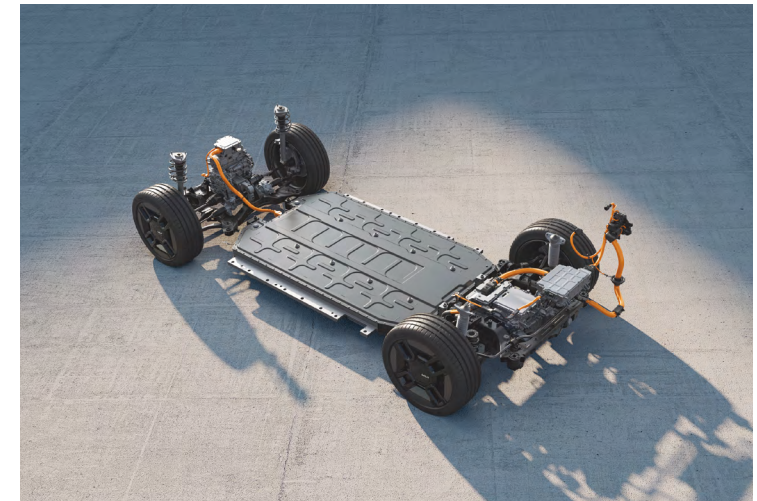

Electric Capabilities

E-GMP forms the basis for the Kia EV9. It offers revolutionary EV technology such as 800-volt ultra-fast charging, bi-directional charging capabilities such as Vehicle-to-Load (V2L), and incorporates the latest generation of EV batteries.

New Sense of Space

With its short front and rear overhangs, long wheelbase, and flat floor, E-GMP revolutionizes usage space for the EV9's six or seven passengers to ensure maximum usability and comfort.

SUV Performance

The platform is engineered to be versatile and offers the best performance for all driving situations. Carefully-designed weight distribution between the front and rear, a low center of gravity despite the elevated ground clearance, and the availability of both RWD and AWD versions form an SUV with a stable, comfortable, and responsive drive.

Powertrain System

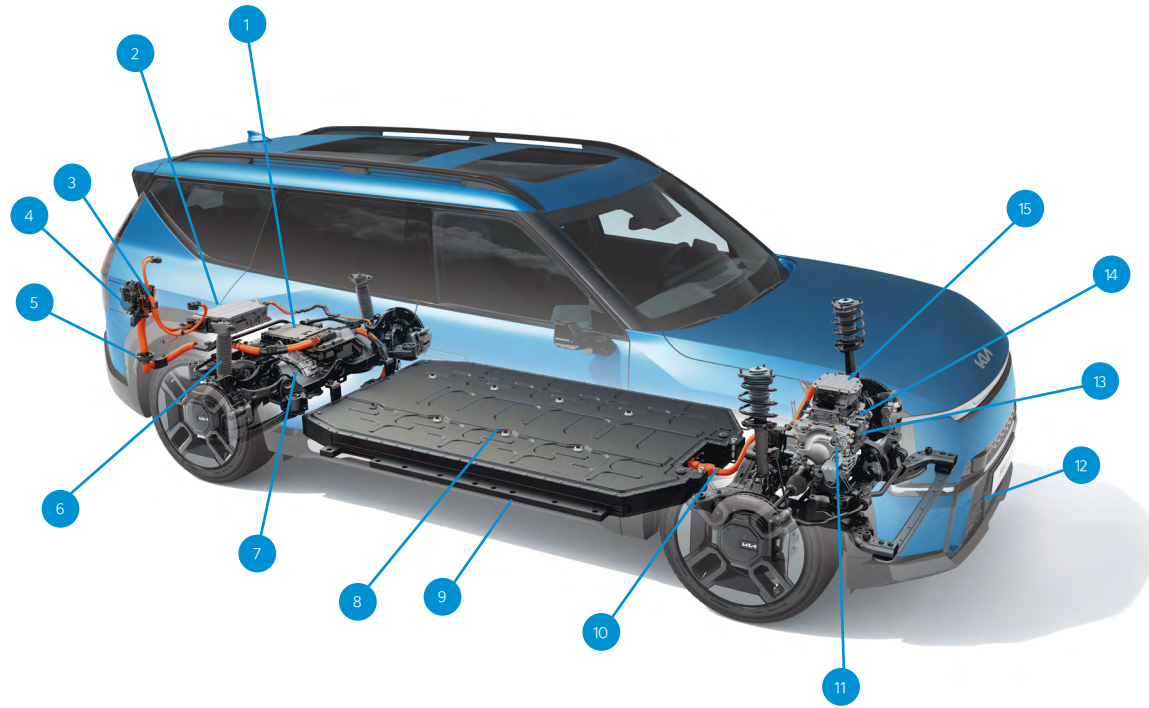

- (1) Rear dual-stage inverter
- (2) ICCU - Integrated Charging Control Unit
- (3) AC cables
- (4) CCS - Combined Charging System socket
- (5) DC cables
- (6) Self-levelizing dampers
- (7) Rear permanent magnet synchronous motor
- (8) High voltage battery

- (9) Reinforced flat floor
- (10) DC cables - front motor
- (11) Front permanent synchronous motor
- (12) Active air flaps
- (13) DAS - Disconnect Actuator System
- (14) VCU - Vehicle Control Unit
- (15) Front inverter

Powertrain System

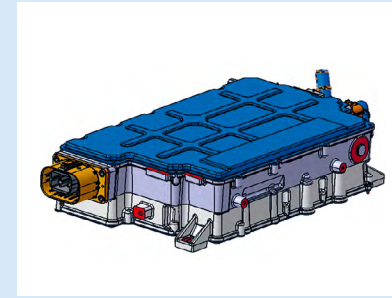

ICCU
Integrated Charging Control Unit
 The ICCU consists of the onboard charger, which converts 220V to 800V, a low DC-DC converter, which converts 800V to 12V, and the bi-directional charging unit, which converts 800V to 220V. It is therefore responsible for bi-directional charging and the lower power electronic systems.

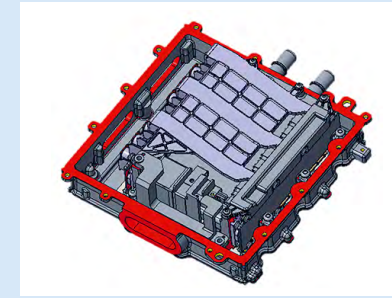

Rear Dual-Stage Inverter
 The Dual-Stage Inverter is installed to the main rear drive motor and comes with silicon carbide (sic) power modules. It increases the power efficiency and the torque through a 2-stage control. Additionally, when connected to a 400V charger, the system uses the internal coil of the motor to boost the voltage to 800V.



DAS
Disconnect Actuator System
 The front motors of all AWD models are equipped with this system. When all-wheel drive is not necessary, i.e. during cruising with a constant speed, the front motor is decoupled completely and only rear-wheel drive is used. This improves energy efficiency and total range by up to 8%. The system connects or disconnects the motor and drive shaft according to the current driving conditions and performance needed.

Front Inverter
 For AWD models, a second front inverter is installed next to the front motor.



Rear self-levelizing Dampers
 If the vehicle height changes due to cargo load, the shock absorber moves up and down in a pumping motion through driving energy to raise the vehicle height to a horizontal position. As a result, the comfort, ride, and driving sound quality are improved.

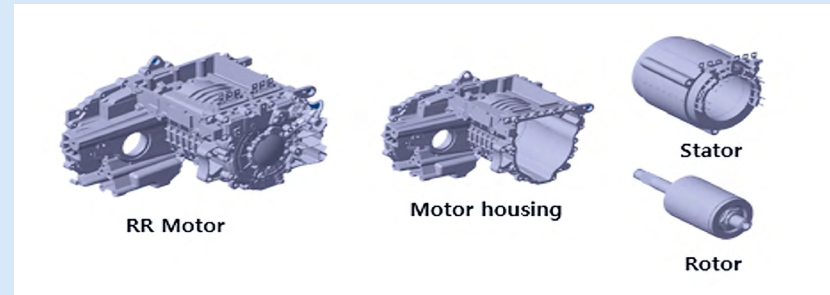

Rear Motor Innovations

- Integrated drive system applied to secure a compact package by using an integrated housing system
- Stator winding technology to increase the stator factor and applying an automation process with hairpin stator
- Development of a high speed rotor with specific rotor core and ball bearing suitable for high speeds
- Self bonding method of stator core (rear wheel motor only)
- Improvement of cooling performance by applying an oil based system
- Dual-Stage motor/inverter system (rear wheel motor only) with stage change depending on the operation point of the vehicle

Stage 1: High efficiency
Stage 2: Maximum power

Battery Technology

The EV9 features the latest battery technology for both the high-voltage main battery and the 12-volt secondary battery.

The fourth generation high voltage battery offers a greater capacity and greater energy density per cell compared to the previous generation in order to keep the battery as compact as possible.

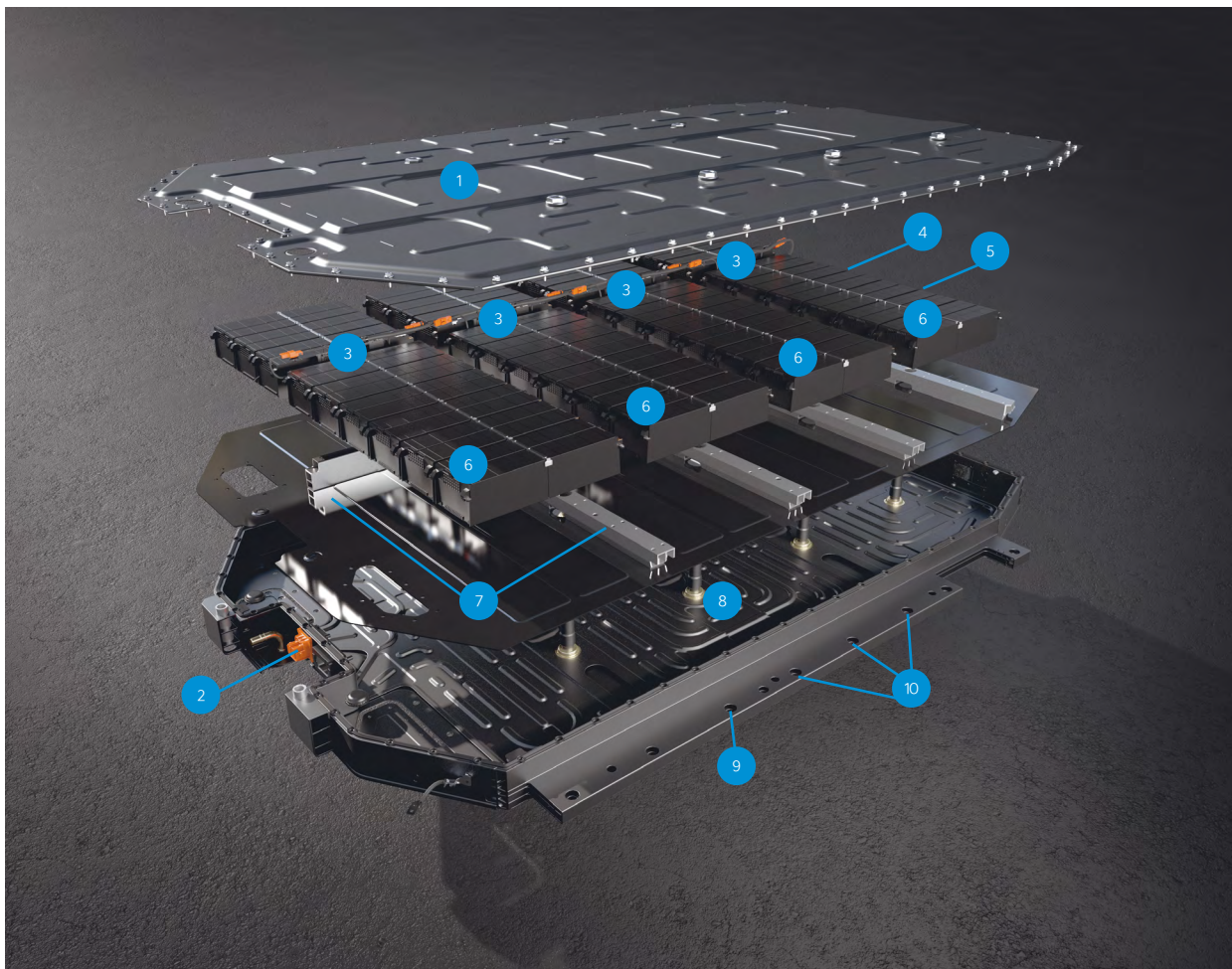

- (1) Battery pack case
- (2) Front high voltage connector
- (3) CMU - Cell Monitoring Units
- (4) BMU - Battery Management Unit
- (5) Rear high voltage connector
- (6) Battery modules
- (7) Reinforced intersection members
- (8) Battery cooling channels
- (9) Side and bottom protection
- (10) Battery fixation points

Battery Technology

High Voltage Battery

Type:	Lithium Ion Battery
Modules:	38
Cells:	456
Weight:	566.5 kg
Volume:	379 liters

Energy density comparison

3 rd gen. battery cell	▶▶▶	4 th gen. battery cell
618 Wh/L / 284 Wh/kg		670 Wh/L / 295 Wh/kg

Increase of 8.5% per liter of battery volume.

The new 12-volt eAGM battery (electric vehicle Absorbent Glass Mat Battery) was specifically developed for EVs to respond to increased power usage during parking and starting, and to increase the overall battery durability.

In an eAGM battery an absorbent glass mat absorbs and holds the acid to prevent it from flowing freely within the battery. This glass mats also separate the positive and negative plates from one another.

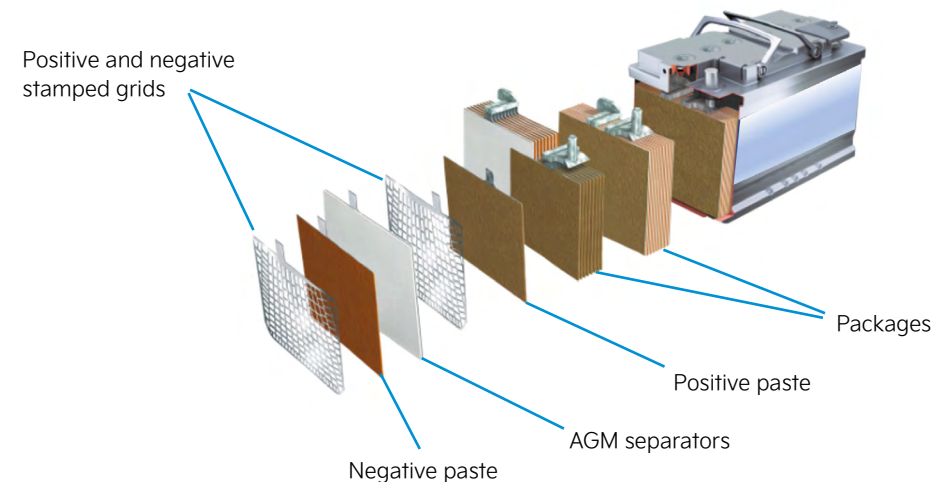

Advantages compared to standard batteries:

- Up to 2 times longer time of usage
- Less sensitive to climate influences
- Capable of handling high electrical loads
- Higher vibration resistance
- Non-spillable and maintenance-free
- Greater mounting flexibility

Multi-Fast Charging System

Thanks to 800-volt ultra-high speed charging, 15 minutes of charging results in up to 249 km of all-electric driving range for the RWD version and up to 226 km for the AWD versions. This means that the EV9 can be charged from 10% to 80% in only 24 minutes, which equals 70 kWh of energy delivered to the battery. With the multi-charging system, drivers can use both 800V ultra-high speed chargers or the more common 400V fast-chargers.

Multi-Fast Charging System

When using 400V charging, the Kia EV9 uses the electric motor and rear inverter to convert the 400-volt current from the charger to 800-Volt for the car. All of this happens smoothly, automatically and quickly to ensure the optimal charging speed.



How does it work?

Simply connect the Kia EV9 to any charging station and the vehicle will detect the current of the charger (400V or 800V), adapt automatically, and always use the maximum possible charging power.

Bi-Directional Charging

Tomorrow's mobility sees EVs as much more than just a means of transport. EVs can be energy storage devices that pass on their energy to households, the grid or buildings when needed.



Thanks to its innovative platform and increased battery capacity, the Kia EV9 can function as the ideal power supply for daily life or leisure activities. Similar to the Kia EV6, the EV9 is capable of discharging 3.68 kW via the V2L outlets. Every EV9 is also ready for smart charging (V1G), Vehicle-to-Grid (V2G), and Vehicle-to-Home or Vehicle-to-Building (V2H/V2B). These features will gradually be introduced throughout European markets.

In the future, thousands of EVs connected to the grid could act as a virtual power plant, potentially providing enough energy to temporarily power cities.

Bi-Directional Charging

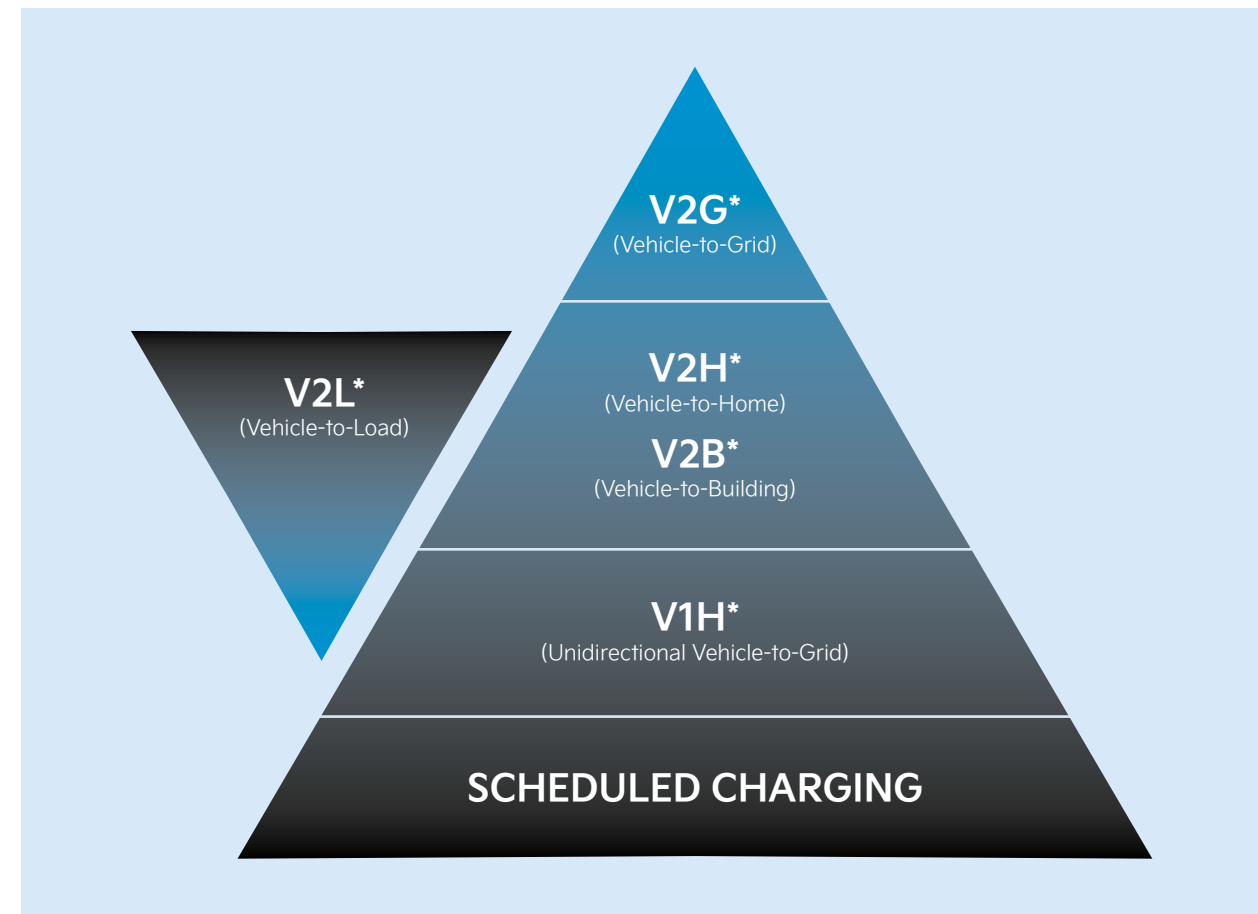

How does it work?

Scheduled Charging

Based on the driver's selection, the system decides whether the EV9 charges exclusively or with priority during the specified off-peak period. It allows charging to be controlled manually by the user.

Unidirectional Grid-to-Vehicle (V1G)

With V1G, electricity is supplied to the EV9 based on various factors (e.g. favorable electricity prices) either from a photovoltaic system or the public electricity grid. V1G dynamically manages the EV9's power and charging times to provide cost benefits - for example, it is charged when it is cheapest.

Vehicle-to-Home (V2H) & Vehicle-to-Building (V2B)

With V2H or V2B, the EV9 serves as a power supplier and buffer for private / semi-private use. The EV9 acts as energy absorber (e.g. when solar energy is high) and emitter when it is needed (e.g. when there is no solar energy).

Instead of buying and adding new batteries for storage, the existing batteries in the EV9 can be used as storage.

Vehicle-to-Grid (V2G)

With V2G, the EV9 serves not only as an electricity storage and buffer for buildings, but also for the electricity grid.

Customers return electricity to the public grid via their EV9 in exchange for a kilowatt-hour price.

Vehicle-to-Load (V2L)

V2L can be divided into two types: V2L Inside (socket in the interior) and V2L Outside (V2L connector in the charging socket). Both deliver a maximum output of 3.68 kW which can be used to charge or power electric devices or other electric vehicles.

THE KIA EV9 Driving



Powertrains

The Kia EV9 comes with two different powertrains: RWD and AWD.

RWD (Rear-Wheel Drive)

The RWD version is equipped with a permanent magnet synchronous motor positioned on the rear axle with a total output of 150 kW and 350 Nm of torque.

Rear Motor

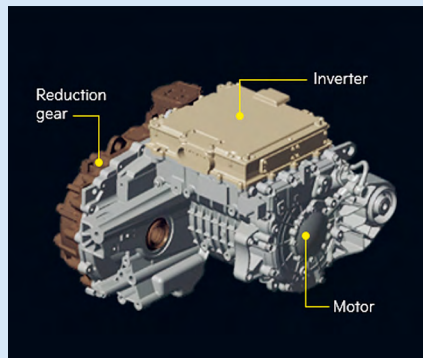

AWD (All-Wheel Drive)

The AWD version is equipped with two permanent magnet synchronous motors, one on each axle, with a total combined power output of 283 kW and 600 Nm of torque. Depending on the market, it is also possible to upgrade the Baseline AWD version with an additional 100 Nm of torque for a combined torque of 700 Nm, thanks to Kia Upgrades. This upgrade is already available for vehicles registered in Germany. The EV9 GT-Line comes standard with 700 Nm of torque.

Front Motor

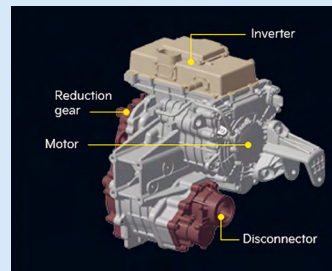

Rear Motor

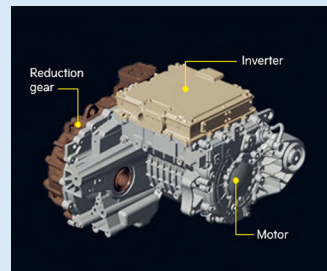

Technical Specifications

	Baseline RWD	Baseline AWD	GT-line AWD
Battery Capacity (kWh)	99.8	99.8	99.8
Power (kW)	150	283	283
Torque (Nm)	350	250/350	350/350
Top Speed (km/h)	185	200	200
0 → 100 km/h	9.4	6.0	5.3
Energy Consumption (kWh/100km)	20.2	22.3	22.8
All-Electric-Range (km)	563	512	505

Consumptions and emissions were determined according to the standardized EU measurement procedure (WLTP). The individual driving style and other external factors have an influence on the actual efficiency. (October 2023)

Disconnect Actuator System



The EV AWD Disconnect Actuator System (DAS) is a device attached to the EV9 front motor, disconnecting or connecting motor and drive shafts according to the environment.

This allows the vehicle to disconnect the secondary axle from the AWD drivetrain when it is not needed, for example during constant speed driving, and transition the system to 2WD to enhance the vehicle's energy efficiency and range.

As such, this innovative system reduces energy waste and enhances efficiency by 6% - 8%.

Operating Conditions of DAS

Item	2WD → 4WD switching conditions	4WD → 2WD switching conditions
Drive mode	SNOW or SPORT is selected	*The conditions on the left are not met, and the conditions below are met 1. ECO mode is selected (Connection is maintained when vehicle speed is below 15 km/h) 2. ABS is operating
Rapid steering	Steering angle is 60° or more and regular acceleration is 40°/sec	
Driving on steep grade	Grade is 8% or more	
Vehicle speed (km/h)	Vehicle speed is below 15 and above 120 km/h (Normal mode only)	
Accelerator pedal input	Torque input by the driver is greater than the max. torque for rear wheels	
Regenerative braking (using One-Pedal or i-Pedal)		
Electronic brake system operation	TCS or ESC is operating	

Aerodynamics

Despite its massive dimensions and tall SUV stance, the Kia EV9 offers excellent aerodynamic values thanks to a streamlined body and unique technological solutions. The drag coefficient (Cd) of the EV9 is as low as 0.28.



- (1) Front air curtain / active air flap
- (2) 3D underbody
- (3) Low drag wheel
- (4) Digital exterior side view mirrors
- (5) Auto-flush door handle



Aerodynamics

- (1) On the left side: **Front Air Curtain:**
Air is directed along the wheel arches and reduces air resistance.

On the right side: **Active Air Flap:**
Electronically-controlled component behind the lower front grille to cool the vehicle parts or improve energy efficiency by actively opening or closing in order to guide the airflow.



- (2) The redesigned shape of the undercarriage improves the flow of air under the vehicle, and air resistance is reduced. A convex shape in front of the battery and a concave shape behind it optimize air flow and prevent the formation of an air cushion below, increasing the overall aerodynamic efficiency.

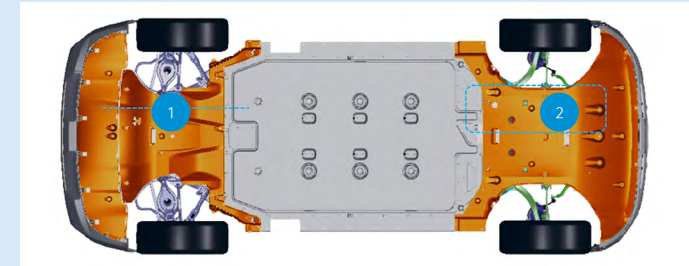

- (3) With regenerative braking, the mechanical brake is not stressed as much. Therefore, the brake stays cooler and closed (aero) wheel designs can be established.

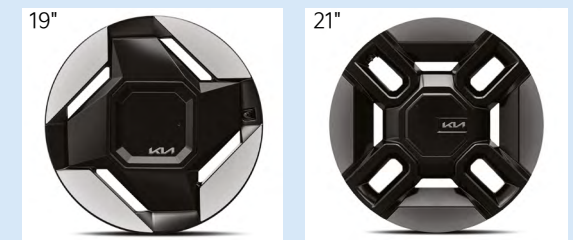

- (4) Digital Exterior Mirrors have two functions

Primary function: Additional comfort and safety element

Secondary function: Aerodynamic advantage over conventional mirrors

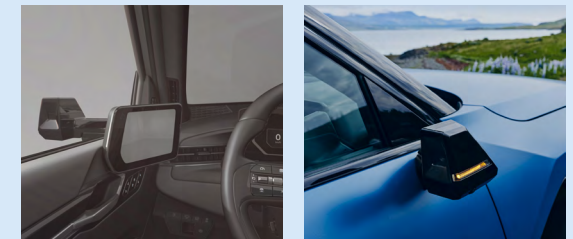

- (5) The redesigned door handles have a sleek, streamlined look. At the same time, the air resistance in the area of the door is reduced.

The auto-flush door handles slide out when someone approaches the car carrying a Smart Key or a Digital Key.

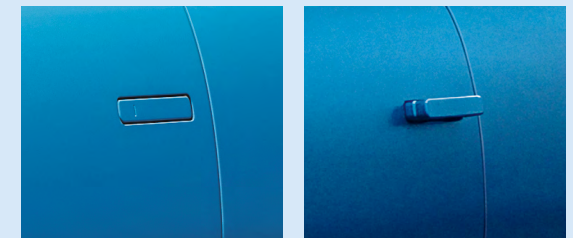

Alternatively, you can press a button on the Smart Key, Digital Key or unlock the car via the Kia Connect App. If the 12V battery should be discharged, a mechanical emergency key can be used to open the car.

All-Electric Range

Electromobility and electric range go hand in hand. The EV9's powertrains have been developed to offer low energy consumption and enable quiet driving. This is especially noticeable in urban and residential areas.

With a range of up to 563km (WLTP, combined), the Kia EV9 caters to nearly all mobility needs.



All-Electric Range



Battery Position

The high-voltage battery can be considered the heart of an EV. It is essential to carefully balance the weight distribution, usage of space and performance.

EV9

The 99.8 kWh battery is positioned underneath the whole cabin floor to distribute the 567 kg of weight evenly. Thanks to this positioning, the battery does not influence luggage space and the EV9 offers one of the largest trunks in its segment in terms of volume.

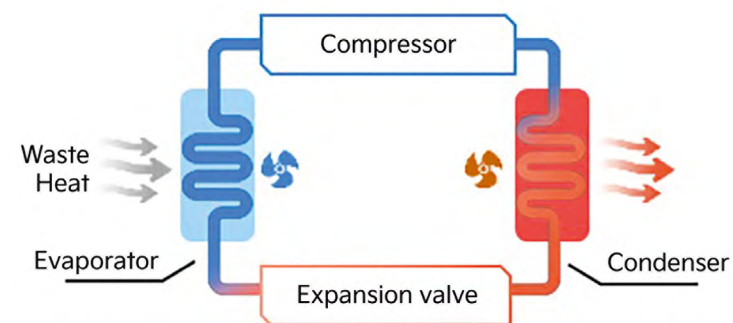

Heat Pump

How does it work?

A heat pump can heat and cool the interior. For cooling, it works similarly to a refrigerator: The system extracts heat from the interior and conducts it to the outside.

What are the benefits?

- 18 - 43% higher energy efficiency compared to conventional heating or air conditioning (e.g. depending on the outside temperature)
- Less energy consumption from the high-voltage battery and thus, more range

Drive Mode Select

The Kia EV9 comes with four different Drive Modes designed to suit different driver preferences on the road. Torque mapping, ESC, energy consuming systems and steering are managed to provide the most suitable driving experience.

<p>ECO: The system focuses on energy-efficient driving, flattening the power curve, reducing energy consumption and saving energy from climate control system.</p>	<p>SPORT: The system focuses on sporty driving, sharply raising the power curve, inflating the driver's seat side bolsters to give more support, and boosting the performance.</p>	<p>NORMAL: The system focuses on balanced driving, moderating the power curve and the energy consumption as well.</p>	<p>MY DRIVE: The driver can regulate all the settings in order to meet their individual driving needs.</p>
---	---	--	---



How to change modes

Press the Drive Mode button (Ref. 1) on the steering wheel to switch between the drive modes.

Ref. 1 Ref. 2

Terrain Mode Select

The Kia EV9 comes with three different Terrain Modes. Depending on the road conditions, when the driver selects the appropriate mode, the system detects four laps of slip and then optimizes driving and braking power. Depending on the active mode, Terrain Mode Select regulates the torque and transmits the power per wheel selectively. The Traction Control System (TCS) reacts to spinning wheels with braking interventions.

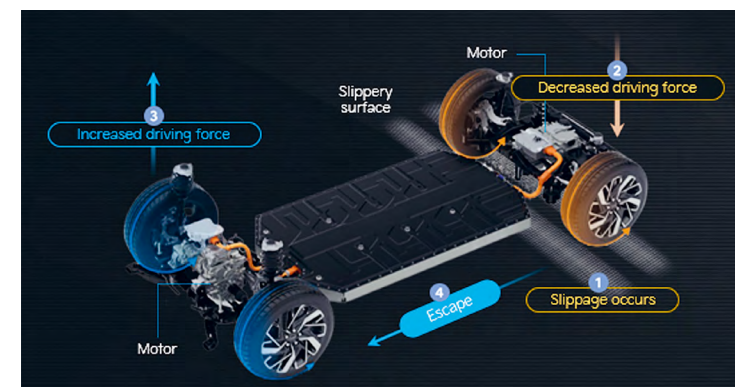
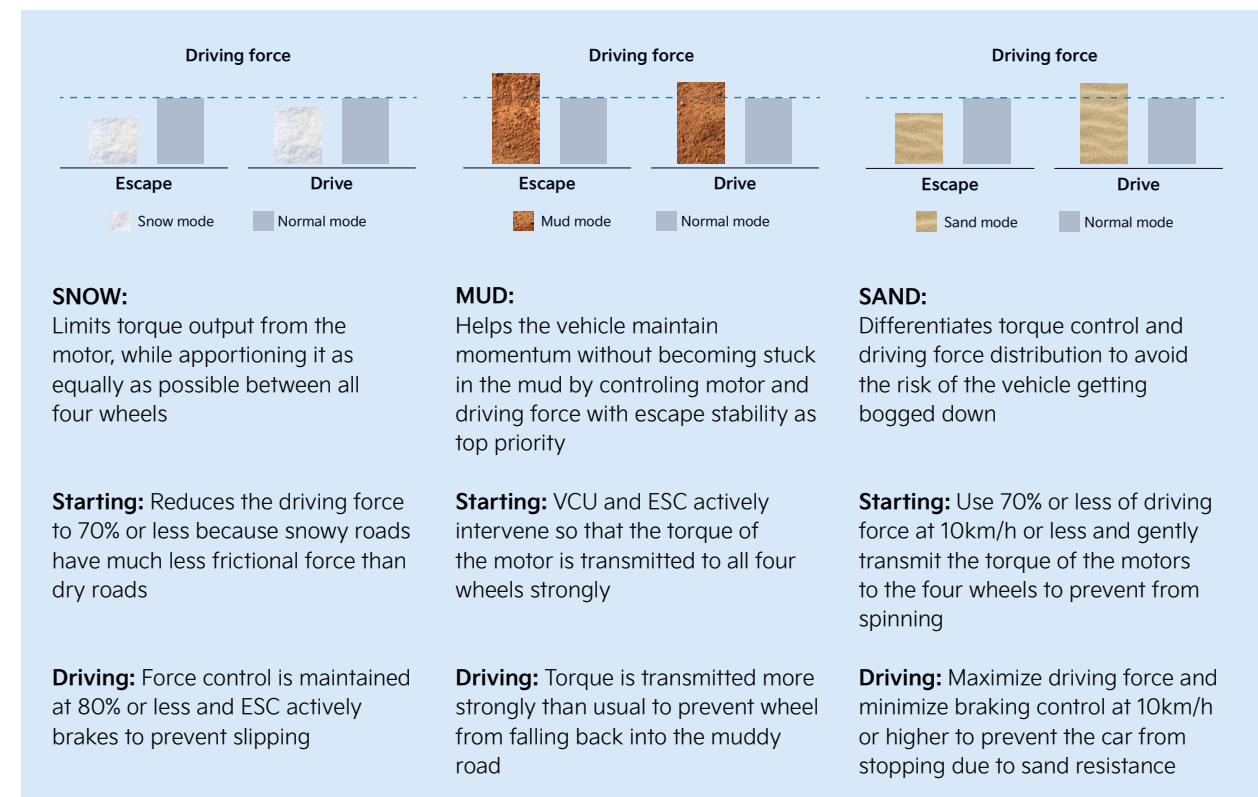

How to activate

Press the Terrain Mode button (Ref. 2) on the steering wheel to switch between the drive modes.

Steering System

Good handling makes the driver feel safe and in control of the vehicle. The handling of a car is heavily impacted by the way it reacts to the driver's input. It should be effortless and precise, but also allow steering corrections and give control to the driver in emergency situations.



Technical Details

The Kia EV9 offers improved steering responsiveness and noise-vibration-harshness (NVH) performance by applying belt-type R-MDPS (Rack-Motor Driven Power Steering) as standard.

Steering System

Thanks to the application of the belt-type rack and pinion motor-driven power steering (R-MDPS) and the increase of the column stiffness, the EV9 offers excellent handling performance and top of the class manoeuvrability.

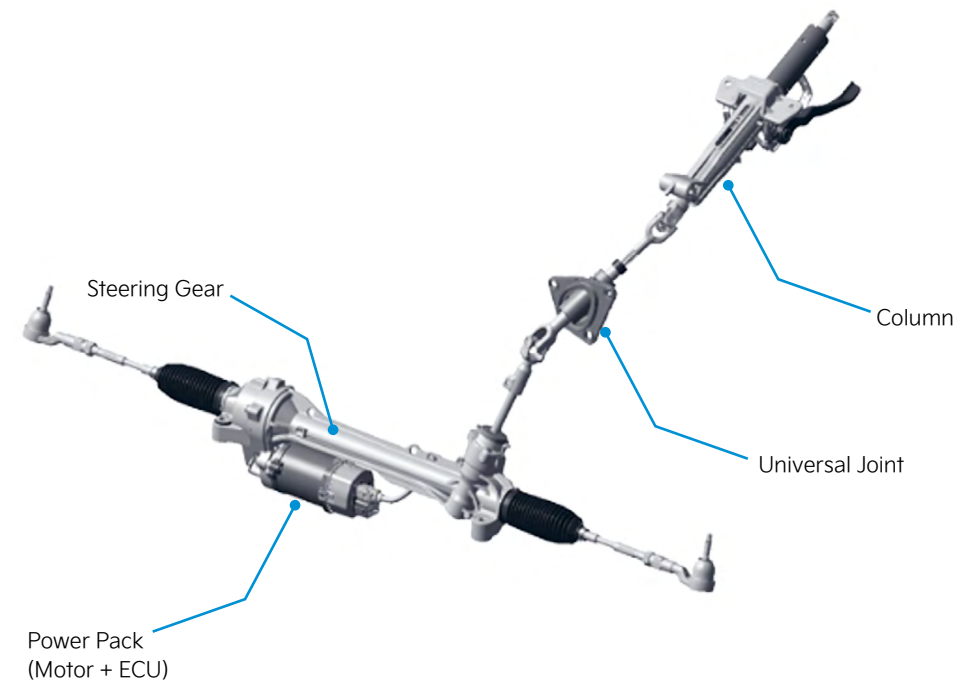

Type	Rack - Motor Driven Power Steering (R-MDPS)
Overall steering gear ratio	16.02 (@360°)
Steering wheel turn (lock to lock)	2.93
Min. turning circle radius in m	6.19 m

Regenerative Braking System

The regenerative brake converts kinetic energy into electrical energy during coasting. The energy is recycled, so to speak, and can be used again to power the EV9.

Regenerative braking can be used and adjusted via the brake pedal or the paddle shifters behind the steering wheel. If the battery is fully charged or regenerative braking is not sufficient to decelerate, the disc brakes will be used. Thanks to an integrated electronic brake, the electronic control enables linear braking at all times. Furthermore, the integration of pressurizing modules and control modules reduces weight and improves braking.



Benefits

- Increased energy efficiency and extended range through regenerative braking
- Less wear on the mechanical brake and thus reduced running costs
- Automated regenerative braking in 'Smart Regeneration Mode'

Regenerative Braking System



Pedal Stop Mode, i-Pedal, Level 3, Level 2, Level 1, Level 0, and Smart Regeneration Mode. These are the names of our seven regenerative braking levels that can be activated via steering-wheel paddles.

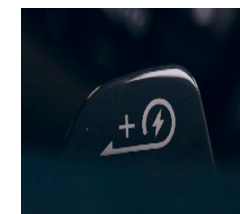

Left steering-wheel paddle

- Stronger braking when coasting
- More energy recovery

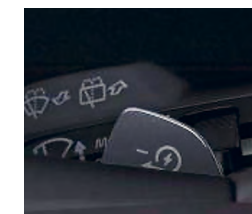

Right steering-wheel paddle

- Weaker braking when coasting
- Less energy recovery

i-Pedal (intelligent Pedal)

With the i-Pedal, the driver can drive, accelerate and decelerate using only the throttle. This is also called one-pedal driving.

How to activate

Press the left paddle one more time over the level 3 (4 clicks starting from Level 0) This introduces i-Pedal driving and the logo is displayed in the vehicle's cluster.

Paddle Stop Mode

- Strongest regenerative brake
- Strongest energy recovery
- **Use case:** Traffic jams (e.g., on the motorway, in the city)

How to activate

Pull and hold the left paddle until the EV9 stops. Paddle Stop Mode can be accessed from any level.

Smart Regeneration Mode

SRBS-Smart Regenerative Braking System

SRBS improves the vehicle's range and stability by optimizing front and rear-wheel regenerative braking. It is operated via the steering wheel paddle switches and adjusts the level of regenerative coasting based on navigation data, for example, before entering a curve, and also based on radar data concerning the traffic ahead.

How to activate

Pull the right paddle for one second to activate the Smart Regeneration Mode. The Smart Regeneration System can be accessed from any level.

Notes

The regenerative brake does not work when

- a trailer is attached to the vehicle
- the brake pedal is applied
- the vehicle is 100% charged
- 'SNOW Mode' is active and the driver wants to engage a level higher than 1
- both paddle shifters are operated at the same time

Structure & Stiffness

The EV9 uses the latest design advances and material technologies to increase the body strength and the safety of all passengers. Thanks to a unique B-Pillar joint structure and new member connections, the collision energy is evenly distributed across the whole body in white.



The Kia EV9 comes with increased thickness in main reinforcements, a solution that improves the overall torsional stiffness.

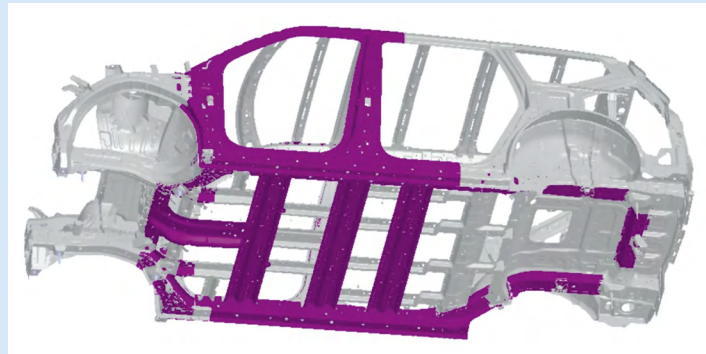

Expansion of hot-stamping process in order to increase the average tensile strength.

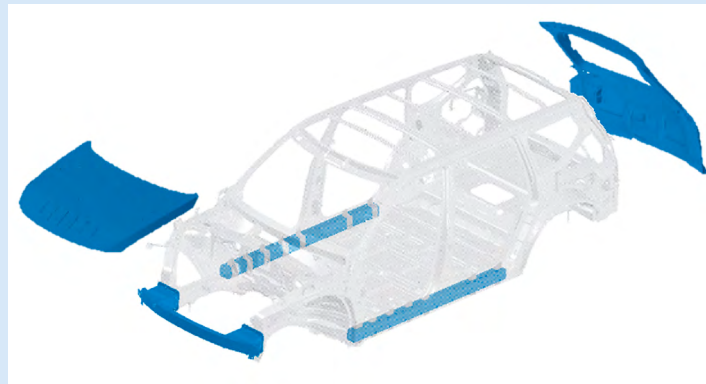

Extensive use of lightweight, high-strength aluminum materials to decrease the weight of the car, improving energy economy and strength-to-weight ratio.

- Aluminum Hood:** 12.7 kg
- Aluminum Front Bumper Rail:** 9.0 kg
- Aluminum Tailgate:** 10.8 kg
- Aluminum Extruded Side Sill:** 27.3 kg

Acoustics & NVH

NVH (Noise - Vibration - Harshness) is one of the main pillars when developing a new electric vehicle in order to guarantee a well-perceived quality and the highest level of driving comfort.

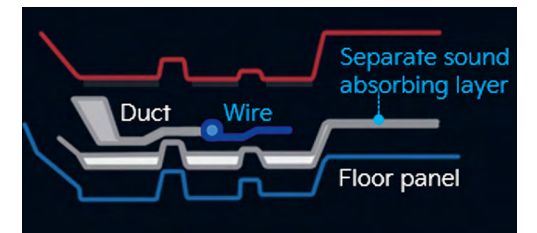
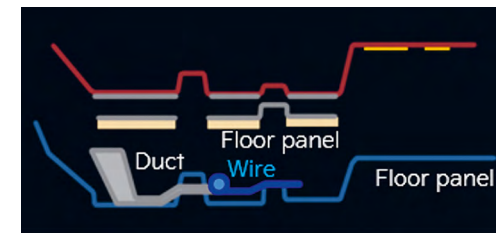

Separated type floor carpet with excellent adhesions between the floor panel and the sound-absorbing material

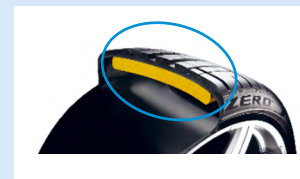

Applied sound-absorbing foam to secure tire quietness in all factory-equipped tires



Enhanced NVH performance thanks to the standard application of sound insulation glass for front/rear doors

Towing

For many customers, the towing capacity of an EV is representative of the vehicle's overall functionality. The Kia EV9 impresses with its excellent value and a maximum towing capacity of up to 2,500 kg. Moreover, the torque distribution ratio between the front and rear motor is fixed at 50:50 for an optimal towing performance.



Towing performance

The EV9 AWD variants are capable of towing up to 2,500 kg, while the RWD variant can tow up to 900 kg.

For the EV9 GT-line the permissible drawbar load is 125 kg and the roof load is 100 kg, which is sufficient for three e-bikes.

Safety

A total of 9 airbags increases the safety of the EV9 passengers in the case of an accident. The airbags are positioned in all three rows to minimize potential threats.

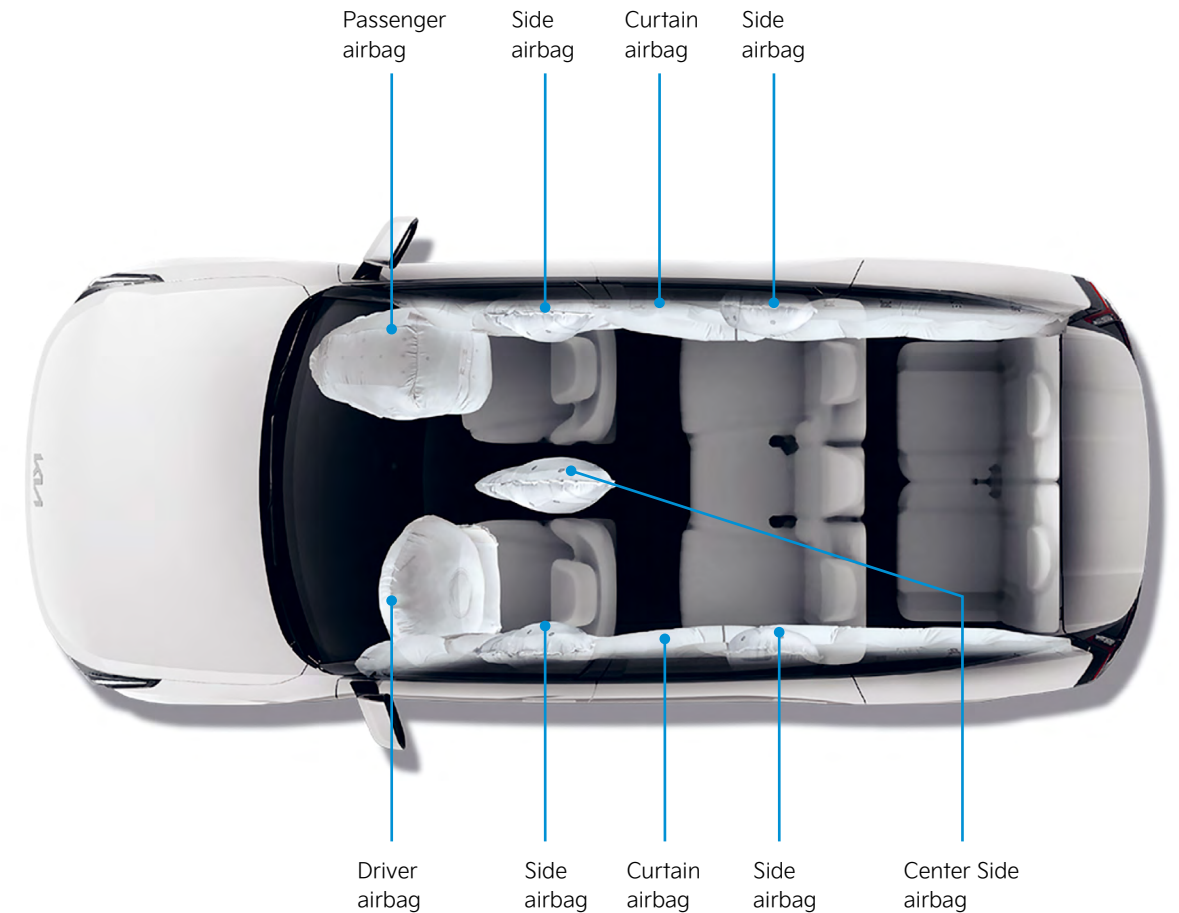

If the EV9 GT-line is equipped with the six-seat layout and second-row swivel seats, the side airbags of the second row are automatically deactivated to avoid malfunctions.

THE KIA EV9 Advanced Driver Assistance



Parking Distance Warning

Provides a warning to avoid a collision with pedestrians and objects around the vehicle while parking or exiting a parking space.



How does it work?

Displays the distance to surrounding objects using color and contour lines while parking and exiting.

- 1 Green: 0.6-1.2 m
- 2 Yellow: 0.3-0.6 m
- 3 Red: until 0.3 m

Rear Cross-Traffic Collision-Avoidance Assist (RCCA)

RCCA helps avoid collisions with approaching vehicles from the left/right side while reversing.



Parking Collision-Avoidance Assist

PCA helps avoid a collision with pedestrians or objects to the rear, side and front while parking or while exiting a parking space.

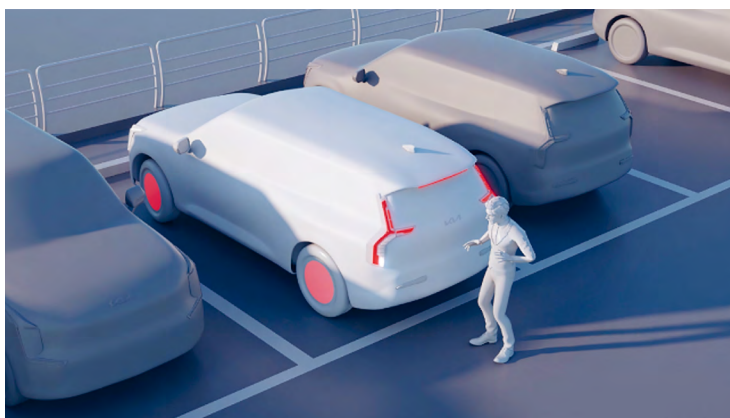

How does it work?

1. When driving at low speeds, warnings are issued and braking control is applied if there is a risk of collision with objects or pedestrians in the front, side or rear surroundings
2. The sensors can manually be activated via the driver assist button in the center console, or they are automatically engaged once the reverse gear was activated or the vehicle was just started

How does it work?

1. Provides a warning and performs braking control if there is a risk of collision with traffic approaching from the rear-corner while reversing. It has been mainly designed for cars, but it can detect also shopping carts, cyclists and pedestrians depending on the size and speed of the object.
2. The rear radar signal is used in order to detect obstacles and initiate necessary counteractions

Safe Exit Warning & Assist

Safe Exit Warning (SEW) provides a warning when a vehicle is approaching from the rear while getting out of the vehicle.

Safe Exit Assist (SEA) helps avoid collisions with approaching rear vehicles when exiting the car by keeping the doors locked if a risk of collision is detected.

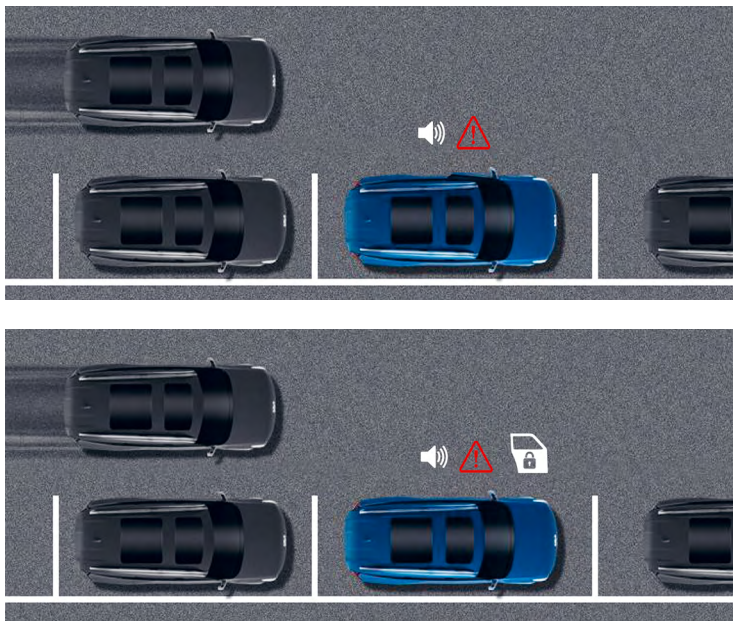

How does it work?

1. The electronic child lock is unlocked to allow rear seat passengers to exit safely
2. If there is a risk of collision with a vehicle approaching from the rear-corner, the electronic child lock remains locked and a warning is issued
3. Safe exit warning (all doors): When exiting the vehicle after a stop, if there is a risk of collision with a vehicle approaching from the rear, a warning is issued

Remote Smart Parking Assist 2

The Remote Smart Parking Assists 2 helps to enter or exit a tight parking spot. The driver can either use remote parking from outside the car or conveniently stay inside, while the EV9 parks itself.

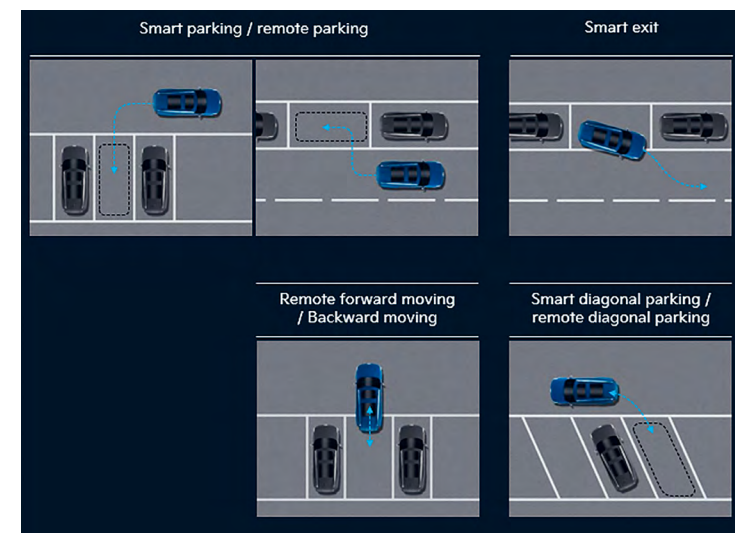

How does it work?

1. Remote Smart Parking Assist uses the ultrasonic sensors and surround view cameras in order to detect other vehicles, parking spots and markings
2. Camera based parking line control is applied if there is no other parked car present

Blind-Spot Collision-Avoidance Assist

The system warns the driver about other vehicles in the blind spots when changing lanes and will also help to avoid any collision by braking and steering.

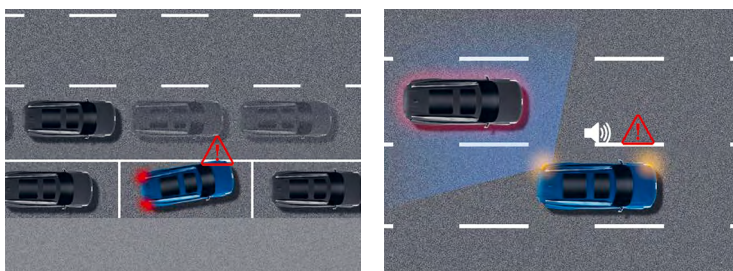

How does it work?

1. While driving, the BCA provides steering control to prevent collisions during lane changes. If the driver does not respond, BCA will counter steer and even apply the brakes to avoid collisions
2. If there is a risk of a secondary collision with surrounding vehicles or objects due to evasive steering, evasive steering is not performed
3. BCA during parallel parking: Provides braking control to prevent collisions with rear-corner vehicles during the parallel forward parking exit

Blind-Spot View Monitor

This feature displays the driver's and passenger's side rear view area to reduce blind spots of the driver.



How does it work?

1. When the turn signal is activated, the cluster displays camera footage from the respective side
2. The bottom SVM camera on the outside mirror is used for this process
3. The field of view is twice that of the mirror, removing blind spots

Surround View Monitor

Surround View Monitor (SVM) helps to drive safely by displaying the surroundings on video when driving slowly or parking.



How does it work?

1. Displays footage of the vehicle's front/rear/left/right camera to create a 360° view.
2. 4 view modes: front view, rear view, 3D view, and rear view while driving
3. To activate either press the camera support button in the center console or engage the reverse gear

High Beam Assist & Intelligent Front Lighting System

The High Beam Assist (HBA) is a feature designed to control the high/low beams according to driving conditions to optimize visibility. Additionally, the EV9 GT-line features the Intelligent Front Lighting System that can deactivate individual LED segments to ensure the highest level of visibility without dazzling other road users.



With this feature, high beams are turned on at night to improve visibility and driving safety, and automatically turned off if an oncoming vehicle is detected.

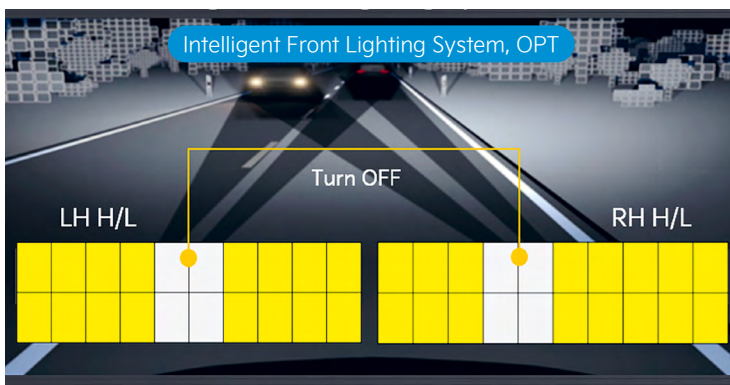

How does it work?

1. Automatic high beam on/off based on detection of surrounding sources of light and preceding vehicles
2. It operates when the light switch is set to AUTO and in the upward position, driving speed of 40 km/h or above, and in dark surroundings

In-Cabin Camera

The In-Cabin Camera is a safety system that detects driver fatigue by tracking the driver's gaze, face position and direction, and eye opening/closing through the camera mounted behind the steering wheel. It works together with Driver Attention Warning (DAW) to issue a warning if it detects an unsafe driving condition.



In Cabin Camera Sensor

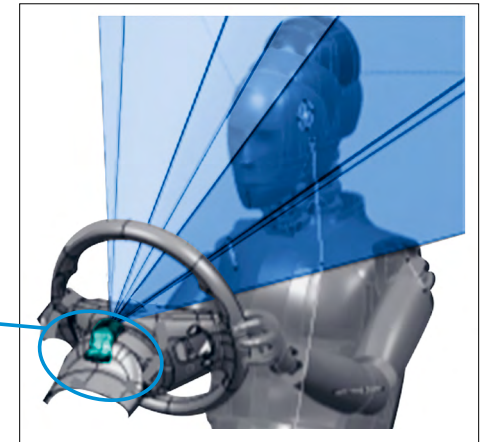

Driver Attention Warning (DAW)

In addition to alerting the driver of possible fatigue, DAW can also detect distracted driving in the case of a lane departure or while stationary it will notify the driver if the vehicle ahead starts moving - for example, while stopped at a traffic light.

How does it work?

1. Analysis of the driver's attention based on lane departure and issuance of warnings if necessary
2. Alert for a stationary vehicle when the vehicle in front starts moving - message and audible warning
3. Alerts on careless driving and will recommend a break when the driver's attention level falls below a certain level

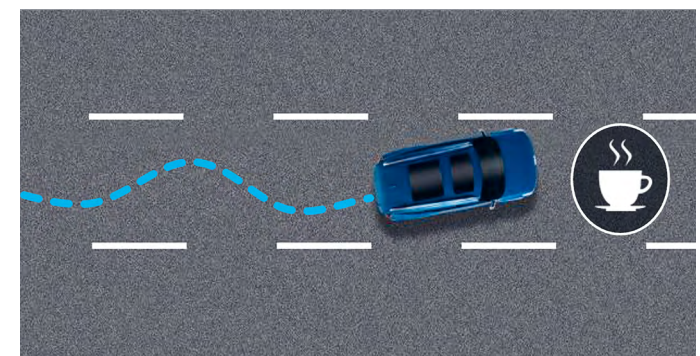

Forward Collision-Avoidance 2

Car/Pedestrian/Cyclist

The system helps avoid collisions with a vehicle, a pedestrian or a cyclist in front of the vehicle while driving.

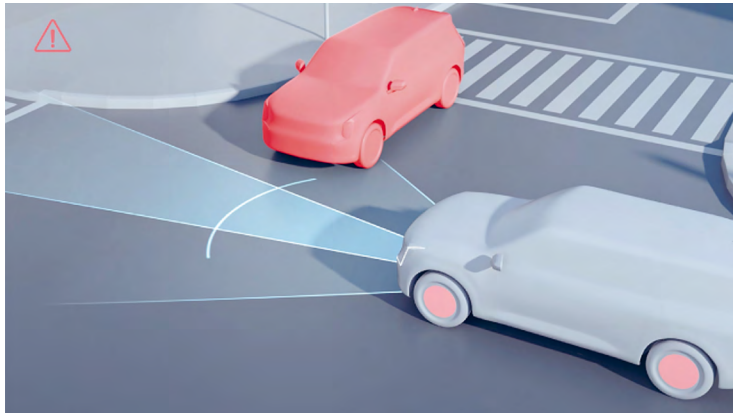

How does it work?

1. Assists the driver in avoiding a collision with a vehicle, pedestrian or cyclist in front while driving by issuing a warning and helps braking
2. Operates in the following sequence:
> warning (step 1) > partial braking (step 2) > full braking (step 3)
3. FCA automatically turns ON when the engine starts, regardless of whether it is OFF in the USM (User Setting Menu)

Junction Turning

An extension of FCA 2 which helps avoid collisions with an oncoming vehicle while turning at an intersection.



How does it work?

1. Assists the driver in avoiding collisions with oncoming traffic when turning at an intersection
2. Provides audible and tactile warnings through the cluster and vibration of the steering wheel if there is a risk of collision with a nearby vehicle
3. This feature is only activated where a left turn is being made by determining the driver's intention based on whether the turn signal has been activated

Forward Collision-Avoidance 2

Lane Change Oncoming

An extension of FCA 2 which helps avoid collisions with an oncoming vehicle while changing lanes.

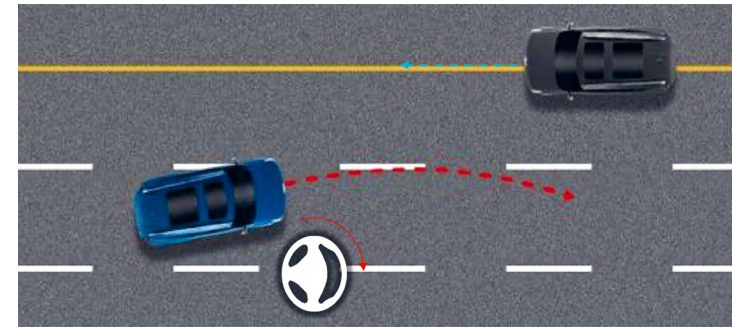

How does it work?

1. If a vehicle is approaching from the opposite direction while changing lanes, the system provides drivers with assistance using warnings and steering assistance to prevent collisions
2. In situations where evasive steering may lead to a secondary collision with nearby vehicles, pedestrians, or cyclists, the evasive steering is not performed

Intelligent Speed Limit Assist

A feature designed to alert using traffic signs and navigation information to display on the instrument panel and help the driver observe road speed limits.

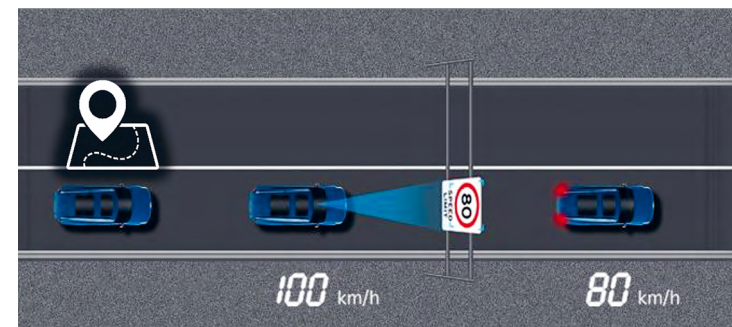

How does it work?

1. Assists the driver in not exceeding speed limits on roads, to ensure safe driving
2. Operates when MSLA or SCC/HDA is on and the speed limit on the road is exceeded

Lane Following Assist 2 & Lane Keeping Assist

The Lane Following Assist (LFA 2) is designed to help detect lane markings and/or vehicles on the road, and assists the driver's steering to help keep the vehicle between lanes.

Lane Keeping Assist (LKA) recognizes the lane including road boundaries and assists the driver in steering when the vehicle departs from the lane without the turn signal being activated.



Difference between LKA and LFA 2

LKA is a driver safety assist feature designed to prevent lane departure at speeds over 60 km/h, while LFA is a convenience feature designed to help maintain the center of the lane at speeds over 0 km/h.

How does it work?

1. Lane Keeping Assist will automatically assist the driver's steering when lane departure is detected to help prevent the vehicle from moving out of its lane
2. Hands-On Detection sensor is applied to precisely judge the driver's presence
3. Lane Following Assist uses the same sensors to center the car for more comfortable driving

Highway Driving Assist 2

Highway Driving Assist 2 (HDA 2) with Hands-On Detection (HOD)

This is a driving convenience function that helps maintain a set distance and speed from the vehicle ahead and assists with lane changes while driving on a highway/motorway and helps center the vehicle in the lane while driving.

HDA is classified as follows depending on its feature and control method:

1. HDA 1: Lane Following Assist (LFA) + Intelligent Speed Limit Assist (ISLA) + Smart Cruise Control (SCC)
2. HDA 2: HDA 1 + Highway Lane Change Assist (LCA)
3. HDA 2 + Hands On Detection (HOD) + Lane Keeping Assist (steering angle-based control, previous: Steering torque-based control). **First applied to EV9**



How does it work?

1. Detects the vehicle in front and lane, and keeps a safe distance from the vehicle in front, maintains a set speed, and keeps the vehicle in the center of the lane
2. The latest models come with a "Highway Lane Change Assist" feature

Hands-On Detection Sensor

When the hand comes into contact with the steering wheel surface, the current is measured on the ammeter. It is applied to improve driver's hands-on/off judgment performance and avoid false alarms to keep the hands on the steering wheel.

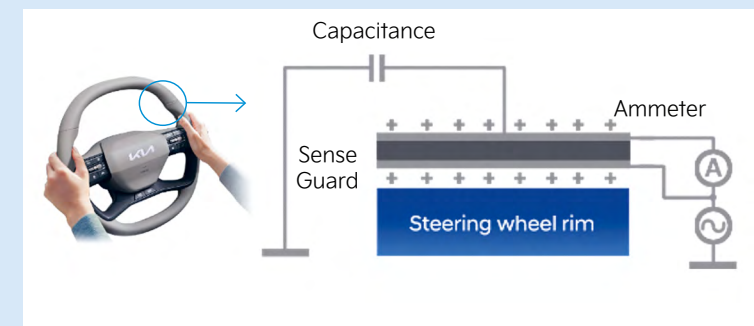

Smart Cruise Control

Smart Cruise Control (SCC) with Stop & Go

It helps maintain distance from the vehicle ahead and drive at a speed set by the driver, including automatic deceleration and acceleration.

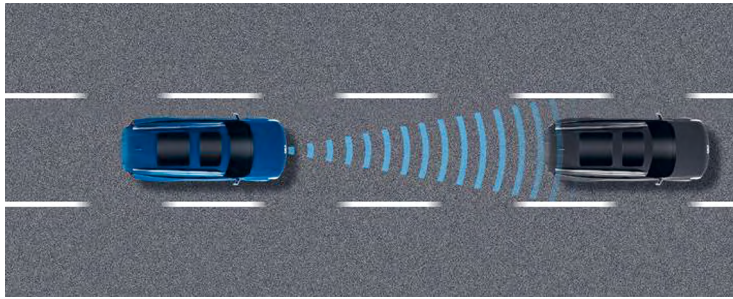

How does it work?

1. A feature designed to detect the vehicle in front and maintain a distance and speed set by the driver
2. Switch on SCC on the steering wheel and define the maximum speed and preferred safety distance
3. The EV9 will now automatically keep the set speed and distance. The driver can interfere anytime by braking or accelerating

Navigation-based Smart Cruise Control Zone (NSCC-Z) & Curve (NSCC-C)

It helps drive at a safe speed while driving highways/motorways main section. The speed is automatically reduced appropriately before entering a zone with a speed limit or a curve. When leaving the zone or curve, speed is reset to the original setting.



How does it work?

1. **NSCC-Z:** Automatically decelerates to comply with the speed limit when the vehicle is driving above the speed limit
2. **NSCC-C/R:** Automatically decelerates according to the curvature of the road to ensure safe driving on curved roads and entrance/exit ramps
3. **AUTO-SET:** When the speed set in SCC matches the road speed limit, the road speed limit is automatically modified to match the speed set in SCC

Smart Cruise Control

Smart Cruise Control - Machine Learning (SCC-ML)

The system helps maintain distance from the vehicle ahead and drive at a speed set by the driver by reflecting the learned driving style of the driver.

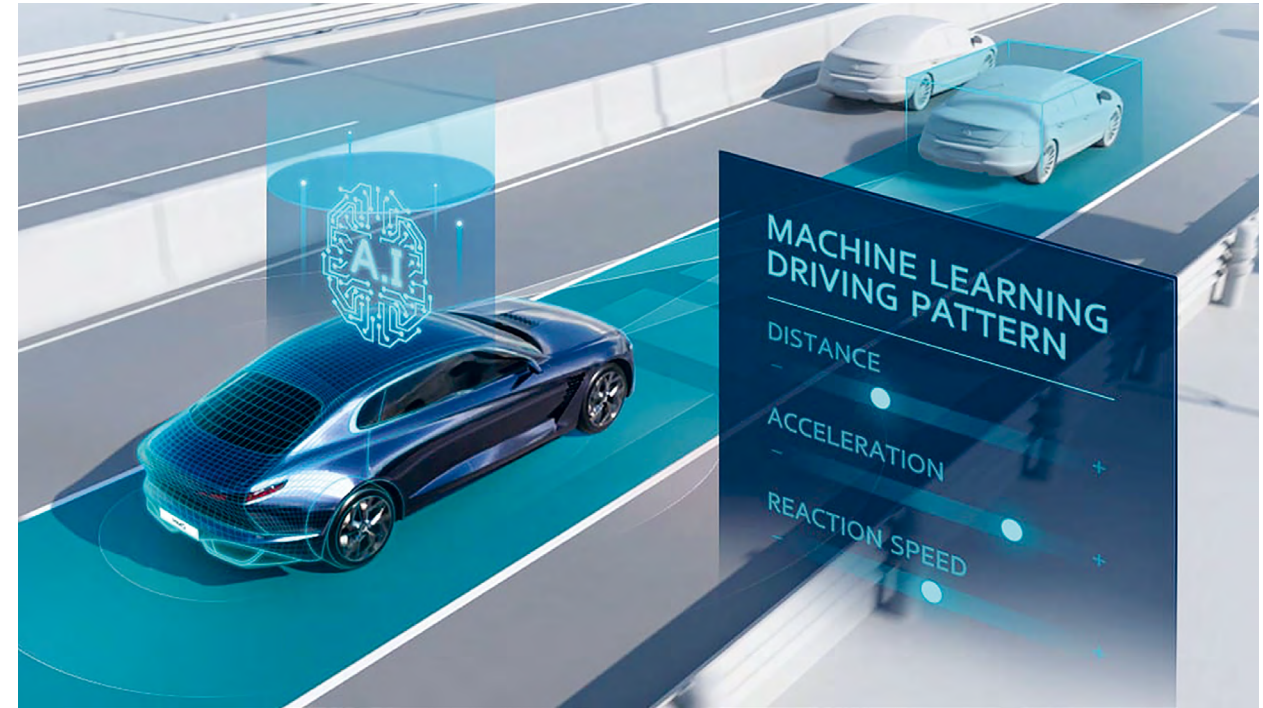

How does it work?

1. AI technology is used to learn the driver's style while SCC is off
2. Reflects the learned information while SCC is on - capable of implementing over 10,000 patterns
3. The technology recognizes and analyzes driving patterns to apply to Smart Cruise Control, creating a customized self-driving experience
4. **The Kia EV9 is one of the world's first cars with such a AI-based ADAS feature.**

THE KIA EV9 Comfort & Convenience



Sustainable Interior

Starting with the EV9, “10 Must Have Sustainable Items” will be applied into all Kia EV models to pursue an ambitious goal: becoming a sustainable mobility solutions provider.

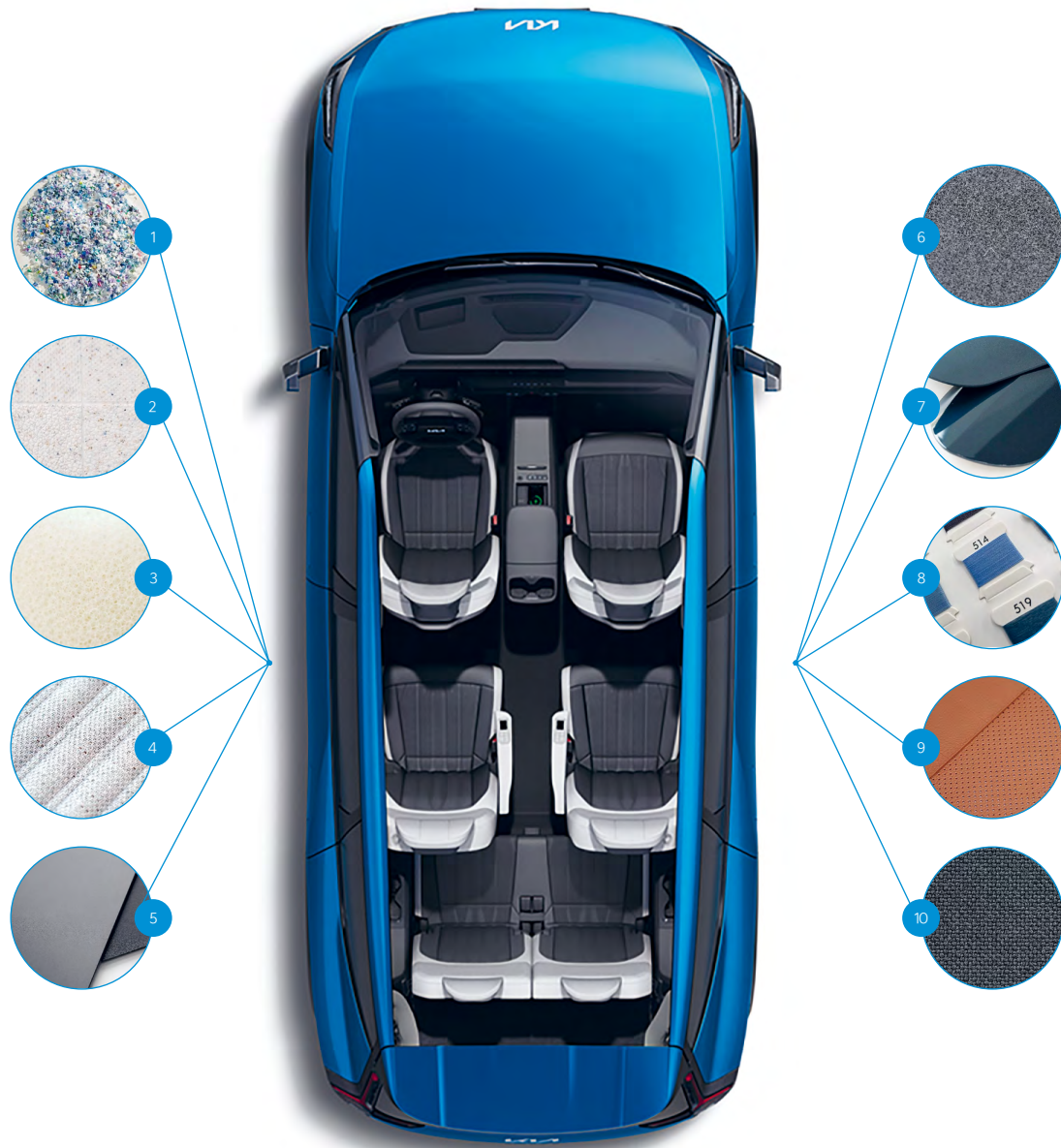

- (1) Bio plastic
- (2) PCM plastic
- (3) Bio PU foam
- (4) Recycled PET fabric

- (5) Bio paint
- (6) Recycled PET felt
- (7) BTX free paint
- (8) Recycled PET yarns

- (9) Bio PU
- (10) Recycled PET fishing net carpet

Seat Configurations

The EV9 boasts three rows of seats, which can accommodate up to seven passengers. The Baseline comes standard with 7 seats. The GT-line can optionally be equipped with one of two innovative six-seat options.



7-Seat Version

The seven-seat version offers the maximum passenger capacity. All five seats in the second and third rows can be folded flat to offer a spacious cargo area. Simply press the electronic buttons on each seat or the remote folding buttons in the cargo area.



6-Seat Relaxation Version

The six-seat option with relaxation seats offers the highest level of comfort for every passenger. The first and second row seats can be reclined and a leg rest extended, so passengers can relax while parked or charging.



6-Seat Swivel Version

The six-seat version with swivel seats offers the highest versatility. Second-row passengers can swivel their seats up to 180° with the help of a lever at the front of the seat. Just pull the lever to the side and the seat can be rotated in both directions.

Unique in its segment, the two seats in the second row can be set to three different positions:

Regular

- Rotation towards the front seats
- Easy access to the Drawer-Style Expanding Console
- Normal airbag functionality

Vis-à-Vis (180°)

- 180° rotation towards the third row of seats into a vis-à-vis position
- If seat rotation is detected, the second-row side airbag is deactivated
Confirmation is given via the supervision cluster

Child Care Mode (90°)

- 90° rotation towards the door with the grab handle on the door frame
- Children can be strapped in more easily
- Physically impaired persons can enter more comfortably

Seat Functionalities

The EV9 offers many features to enhance the comfort for the driver as well as passengers in all three rows. These range from seat positions to heated and ventilated seats.



How does it work?

All EV9 trims come with standard power electric seats in the first row. The GT-line also adds memory and relaxation functions, including a dedicated leg rest.

- (1) Seat Position: Back & Forth / Up & Down
- (2) Backrest Position: Angle of the backrest
- (3) Lumbar Support
- (4) Relaxation Seat
- (5) Leg Rest extension



Once the right settings are applied, you can save up to two driver profiles by pressing **Driver 1** or **Driver 2 (6)** on the door panel.

The memory function will additionally save the correct positioning for the steering wheel and the exterior mirrors.

- (6) Memory function buttons
- (7) 3-Step seat heating
- (8) 3-Step seat ventilation
- (9) Heated steering wheel
- (10) Ergo Motion Seat

For the first time at Kia the EV9 also offers an Ergo Motion Seat. The Ergo-motion driver's seat for increased relaxation and reduced fatigue during the journey through a gentle massage.

Ergo Motion Seat



Air for Comfort

The Ergo Motion Seat adds internal air pockets to comfort the driver. This reduces the seat volume and increase comfort. It also adds a soft massage function for longer drives.

How does it work?

To activate the massage function, press the Ergo Motion Seat button on the door panel and look at the main screen to choose one of the available options:

- Pelvic
- Lumbar
- Whole body
- Off

It can also assist with a comfortable stretch and a lumbar stabilisation program.

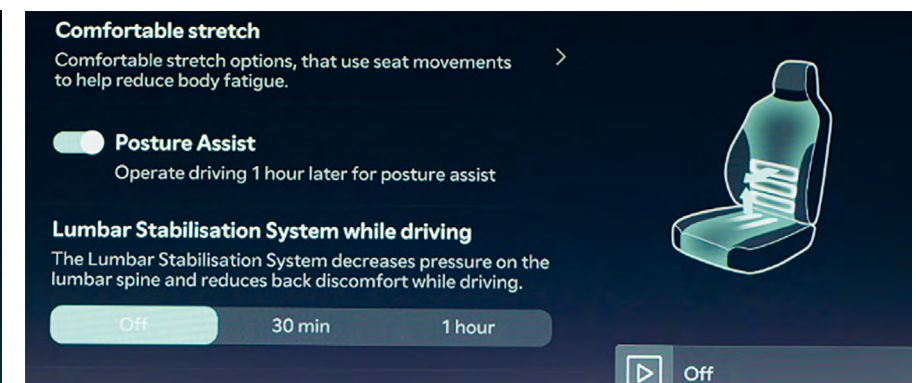
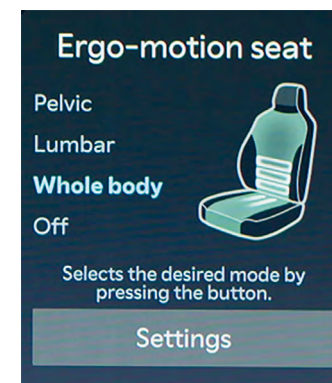

Relaxation Seats

The relaxation function of the EV9 seats ensures comfortable breaks while charging. The reclined position relieves the parts of the body that are under stress while sitting in the same position for a long period of time. The seats can shift to a comfortable reclining position at the touch of a button.

As the first Kia, EV9 can also be equipped with second row relaxation seats in the 6-Seat version of the car. This also brings similar electronic functions to the second row, like the seat, the backrest and the legrest.

The first and the second row relaxation function can be applied simultaneously and up to 4 people can relax together.

How does it work?

1. Press the Relaxation Seat Button on the side of your seat for at least one second
2. A message will appear on the infotainment screen
3. Press the button again and the seat will adjust itself including the leg rest
4. To go back to the original position press the button after your break

Ventilated & Heated Seats - 2 Rows

In all EV9 variants, both the driver and the passengers in the first and second row outer seats can enjoy the perfect seat climate by applying the heating or ventilation function.



How does it work?

1. Simply press the dedicated button on the door panel for heating or ventilation
2. Press again to select the level of heating or ventilation

Front row can choose out of 3 levels each
Second row can choose out of 2 levels each



HVAC System

The EV9 has an innovative and optimized climate control. The car features two independent climate control systems, which create separate climate zones for the driver, front passenger, and rear passengers. Additionally, the ventilation, heating and cooling can be focused on the seats that are occupied by choosing "Driver only", the two climate zones in the front, or all zones.

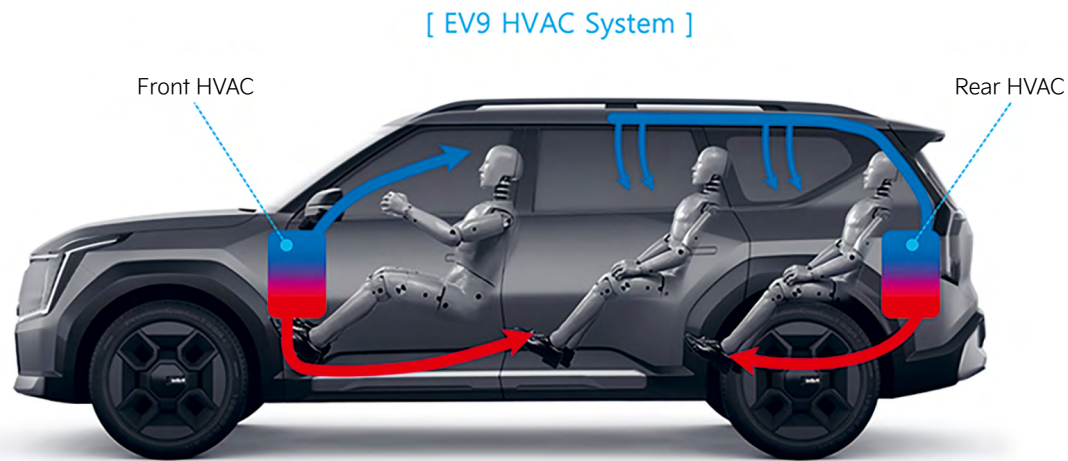

If only two people are driving in the car, the rear A/C can be switched off completely. This increases efficiency and reduces the power consumption, which is especially important in an EV.

The separate rear HVAC for the second and third rows is applied for the first time in a Kia vehicle with the EV9. Additionally, the EV9 introduces an automatic After-Blow System (n/a in the U.K.). This function reduces the occurrence of odors by drying the condensed water that is generated during the cooling process. The After-Blow System is switched on automatically after the air conditioning has been switched off, if the state of the battery charge allows it.

Dual-Color Ambient Lighting

The EV9 features Dual-Color Ambient Lighting in the first and the second row. The colors are fully customizable to fit your current mood, the drive mode, and can even function as an additional source of information. Depending on the mode chosen, the colors can be individually chosen and matched according to your personal preferences, or you can choose from pre-defined color combinations.

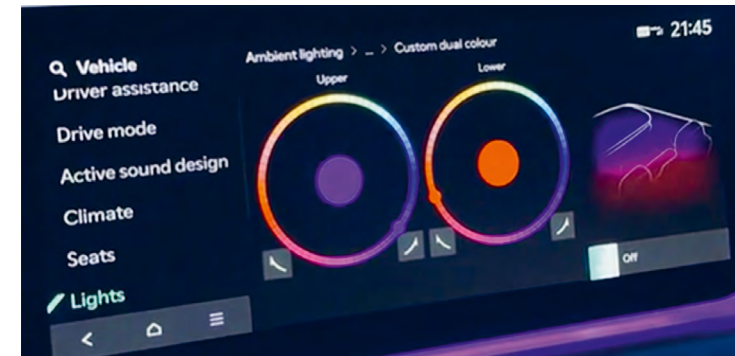

How does it work?

1. On the infotainment screen, enter "Vehicle Settings" then go to "Lights" and "Ambient Lighting"
2. Choose between the functions:
 - Single Color
 - Dual Color
 - Linked to Drive Mode

Optionally, users can also activate the "Link to speed zone alert". This causes ambient lighting to flash at increased speeds to warn the driver about the speed limit. For driving at night, the mood lighting can be dimmed.



Head-Up Display

The Head-Up Display, a 12-inch windshield projection, is a useful addition to the wide and colorful full display cluster. Thanks to its technology, it is highly visible, avoids the use of additional glass panels to improve readability, and it provides the driver with essential driving information at first glance. This includes current speed, navigation directions, and all warnings related to the ADAS system.



How does it work?

The windshield projection Head-Up Display can be adjusted according to the driver's preferences, both in terms of position (moving it in various directions) and content. The driver can select the amount of data to be shown and customize the style of visualization.

When combined with Driver's Memory Seat, its position can be added to the profile and retrieved easily - together with plenty of other saved settings - at the simple touch of a button.

Intuitive Usage

The balanced mix of touch displays, physical buttons and hidden touch buttons support the high-tech qualities of the EV9, while keeping the level of intuitiveness for all users high.



Digital Center Mirror

The Digital Center Mirror optimizes the driver's rearward view through the perfect combination of an analog electrochromic mirror and an integrated video display combined with an additional exterior camera hidden underneath the rear spoiler.



How does it work?

The Digital Center Mirror increases the driver's visibility by offering an panoramic and unobstructed rear-facing view, even if the car is fully loaded.

Push the lever underneath the mirror upwards to activate the Digital Center Mirror. The optical mirror now switches to a digital one. The field of vision is thus extended from 20° to 50°.

The driver can see the image of the rear camera located underneath the rear spoiler. The camera delivers sharp images and is shielded from dirt.

In order to adjust the brightness or camera angle simply use the buttons underneath the mirror.

When the reverse gear is engaged, the display automatically shows a deeper section of the camera.

Digital Exterior Mirrors

The optional Digital Exterior Side View Mirrors increase the high-tech feeling when driving the EV9. Exterior cameras and interior displays replace the optical exterior mirrors.

How does it work?

The cameras and displays are activated automatically when the car is in use and remain on for 7 minutes after the vehicle is switched off to get out safely, even after staying in the car for a short time.

For adjusting or folding the Digital Exterior Side View Mirrors simply use the arrows and buttons on the drivers door panel as you would do for conventional mirrors.



Benefits

- Greater field of vision behind the vehicle
- Better visibility around the A-pillar
- Easier handling when backing up
- More safety when changing lanes and in urban traffic
- A wide-angle function and auxiliary lines both when reversing

THE KIA EV9 Infotainment & Connectivity

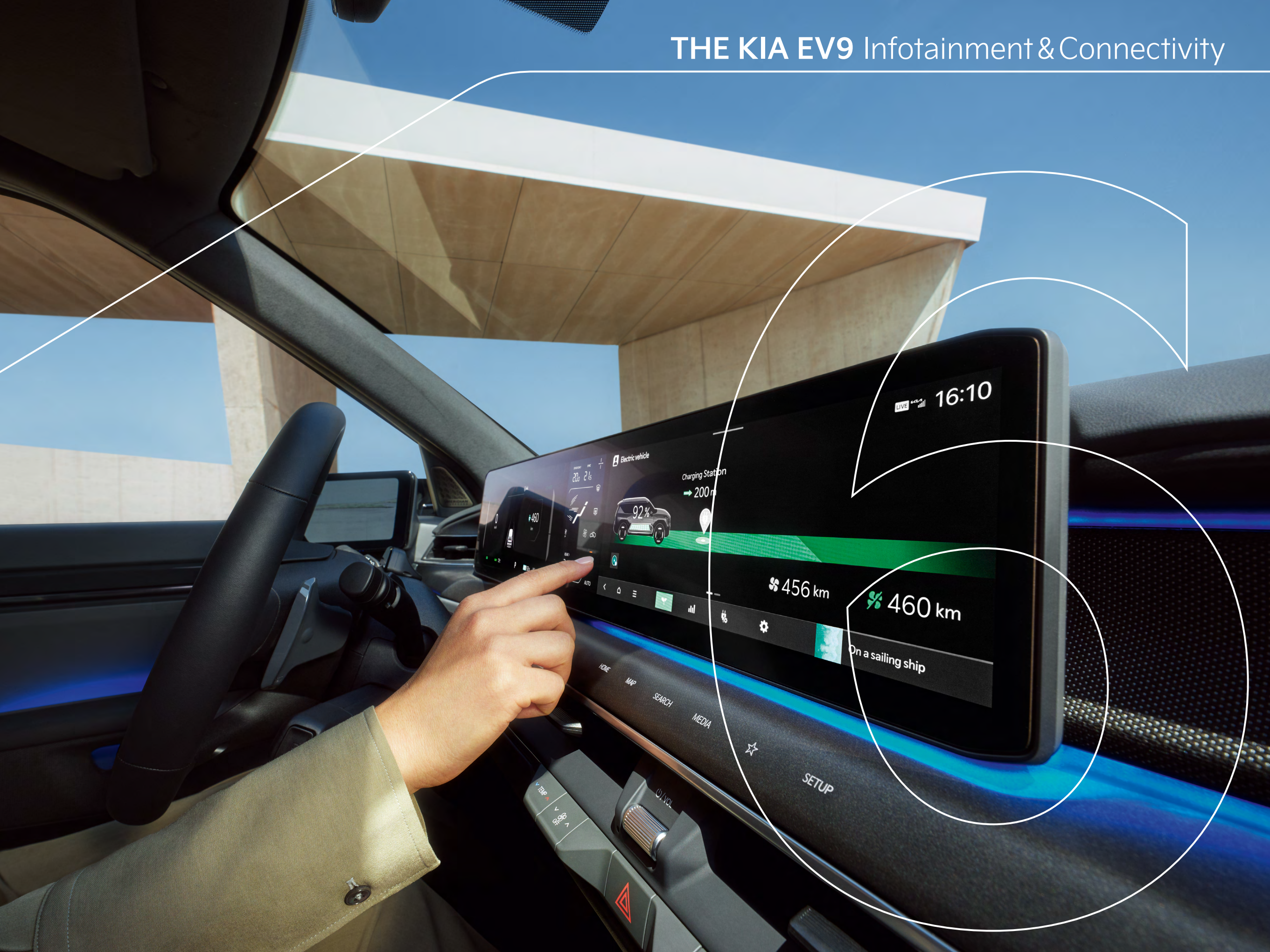

LIVE 16:10

Electric vehicle

Charging Station
→ 200m

92%

456 km

460 km

On a sailing ship

HOME

MAP

SEARCH

MEDIA

SETUP

Connected Car Navigation Cockpit

The EV9 is the first Kia vehicle to embed the Connected Car Navigation Cockpit (CCNC), starting a new chapter in Human Machine Interface (HMI) for intuitive operability. With a Panoramic Wide Display combining a 12.3" cluster, a 12.3" infotainment screen, and a 5.3" HVAC segment display, the seamless and intuitive HMI experience puts all the relevant information within the driver's eyeline. CCNC embeds Nvidia Drive technology supporting the next generation of software-defined vehicles.



The center 5.3" HVAC screen is located between the cluster and navigation dashboard. It allows the temperature and seat heating settings to be easily changed.

CCNC also provides an optimized response time when operating the screens. This is thanks to a RAM memory upgrade and improved location accuracy due to a new, dual-band GPS.

Voice recognition uses Natural Language Understanding providing a more seamless experience.

The cluster graphic design changes according to the different drive modes:

- Comfort
- Sport
- Eco

Connected Car Navigation Cockpit



Comfort Mode



Sport Mode

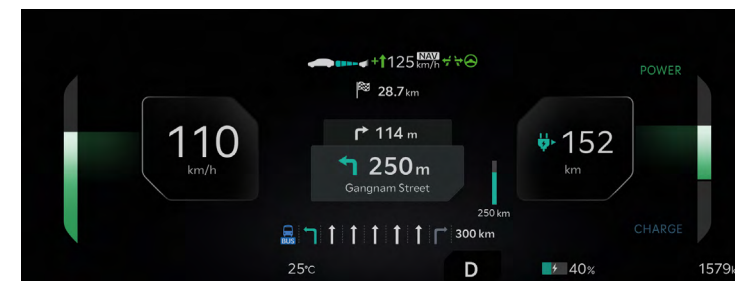

Eco Mode



5.3" HVAC screen

Triple Panorama Display

The Triple Panorama Display is divided into three segments, fulfilling different purposes in order to conveniently show all the necessary information to the driver and passenger.



Triple Panorama Display

(1) 12.3" Supervision Cluster

This display provides all necessary and valuable information directly to the driver. It replaces the traditional speedometer and tachometer dials and extends it with a multi-function display, which can be controlled via buttons on the steering wheel. It can display navigation information including turn-by-turn navigation, audio information, phone calls and contacts, and in-depth trip information.

(2) 5.3" HVAC Touch Display

All HVAC (Heating Ventilation Air Conditioning) functionalities can be accessed via the 5.3" touch display. It provides quick select buttons for the mode selection, front-windshield defroster, rear-windshield defroster, fan speed, and also driver only and sync buttons. By pressing the + symbol in the upper right corner, the display is extended to the infotainment screen for even more detailed settings and the access to the rear climate control.

(3) 12.3" Navigation and Infotainment Touchscreen

The large center display gives you and your passengers access to all multimedia, navigation, and setting functions of the EV9. Simply use the intuitive touchscreen.



Kia Connect

Designed for Android and Apple smartphones, the Kia Connect App offers complete peace of mind with a whole range of features dedicated to providing diagnostic data about the status of your car and the trips you take. The app can also activate a range of remote functions and features when you are away from the car.



From the Kia Connect App, the customers can access the new Kia Connect Store, where Kia upgrades are available.

Kia Connect

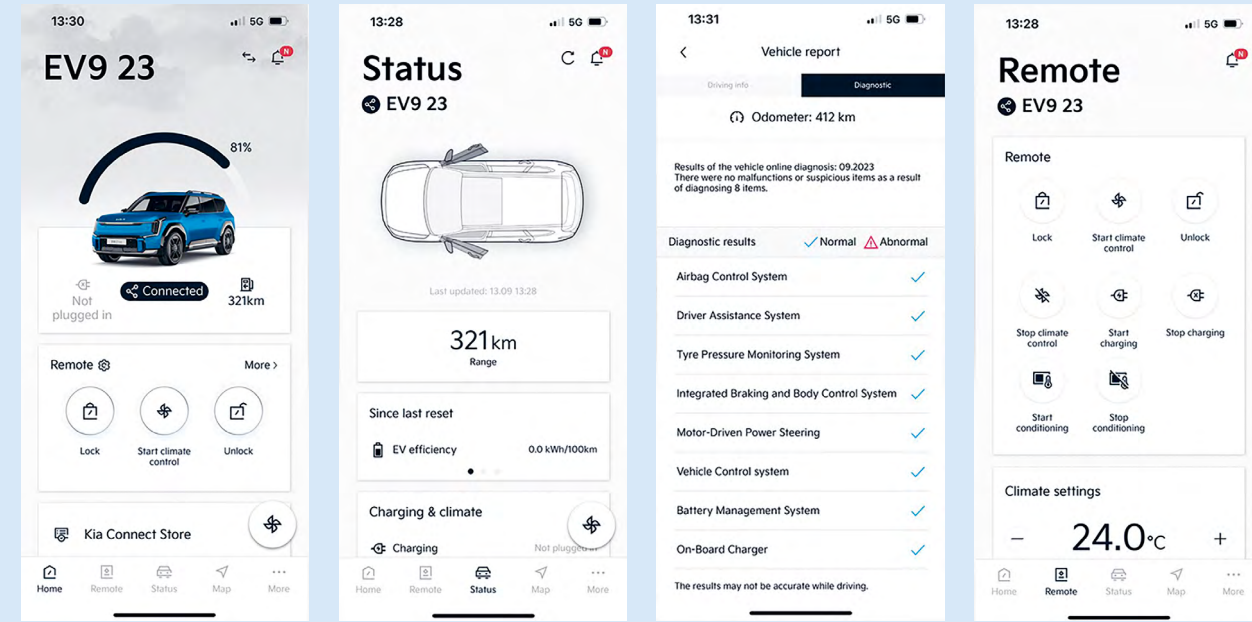

Home Menu

Access all main Kia Connect functions from the menu screen of the app.

Vehicle Status

Offers an overview of key elements of your car's status such as door lock status, battery, and charging level.

Vehicle Report

Offers an overview of the car diagnostics showing abnormal situations or malfunctions.

Remote Controls

Use the remote controls to lock/unlock your car, to start/stop charging and other features.



Last Mile Navigation

Remote service allowing the driver to continue navigation to the final destination on the smartphone after s/he has parked the car.



Find my car

Tells you the last known location of your vehicle - ideal if you are parked in a large car park.



Rear Occupant Alarm

The driver receives push up notification if sensors located in the rear detect any movement.



User Profile Transfer

Driver can check and change vehicle settings on the Kia Connect App.



Send to car

Allows you to pre-plan and set your journey through the app for seamless use in the navigation system.

Kia Upgrades

The Kia Connect Store offers freedom of choice. Browse innovative features to personalize your vehicle even after the initial purchase. The customer can access the store through the Kia Connect App and choose from a range of optional features, such as Acceleration Boost or RSPA 2.

How to purchase a feature

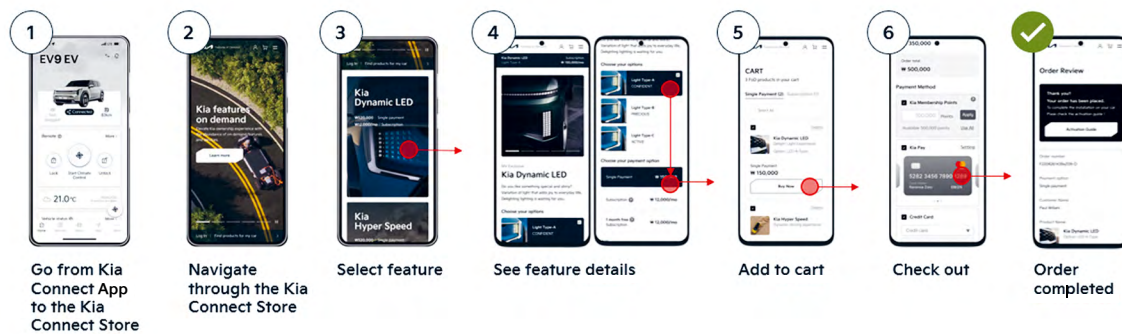

How to install the purchased Kia Upgrades feature in the car

1. The installation notification will be displayed when the vehicle starts
2. After stopping the engine, the system will ask you to perform the activation of your new feature
3. Activation in progress
4. A pop-up appears, telling the customer the feature activation was successful



Benefits

Flexibility

Flexible reconfiguration of vehicle and purchase methods at any time without visiting a dealership (one-time purchase, short-term purchase)

Personalisation

Customizable content & features that support personal preference and style

Future Proof

Innovative technology which will continuously be updated and introduce new features



Digital Key

The Kia Digital Key 2.0 uses Ultra Wide Band (UWB) and Bluetooth Low Energy (BLE) technology, in addition to Near Field Communication (NFC) from the previous version. It can be installed on the smartphone for touch control or remote control, as well as key sharing with family and friends.



Digital Key Share

The Digital Key App lets you share your digital key with up to three people. You can choose the sharing period and features.

Door Lock & Unlock

Without taking your smartphone out of your pocket or opening the Digital Key App, you can lock/unlock the door.

Vehicle Start & Stop

Without taking your smartphone out of your pocket or opening the Digital Key App, you can just start and stop your EV9.

Remote Control

The Digital Key App allows you to lock/unlock doors, start remotely and open/close trunk (up to 10 meters away).

Premium Sound System

The EV9 provides a rich and faithful sound performance due to its Meridian premium sound system. This consists of 14 high-performance speakers using NATec (Natural Wood Fiber Core with transparent UV-protection) material for the woofer diaphragm and a Titanium Dome tweeter developed by Dr. Kurtzmuller in Germany. This is in addition to an external amplifier that guarantees powerful sound reproduction by applying high output and high voltage by an boosted power IC.



Meridian technologies



Intelli Q
Audio volume/quality compensation according to vehicle speed



Horizon
Simultaneous adjustment of music playback image and surround sound







Movement that inspires